

Mobile Crane Grue mobile

LTM 1300-6.2

Technical Data
Caractéristiques techniques



LIEBHERR

Table of content

Tables des matières

Technical Data · Caractéristiques technique

Dimensions · Encombrement	3
Boom/jib combinations · Configurations de flèche	4 – 6
Weights, Working speeds · Poids, Vitesses	7
T	8 – 14
TK	15 – 31
TNZK	32 – 48
TF	49 – 58
TN	59 – 75
Equipment · Equipement	76 – 77
Description of symbols · Explication des symboles	78
Remarks · Remarques	79

Dimensions Encombrement

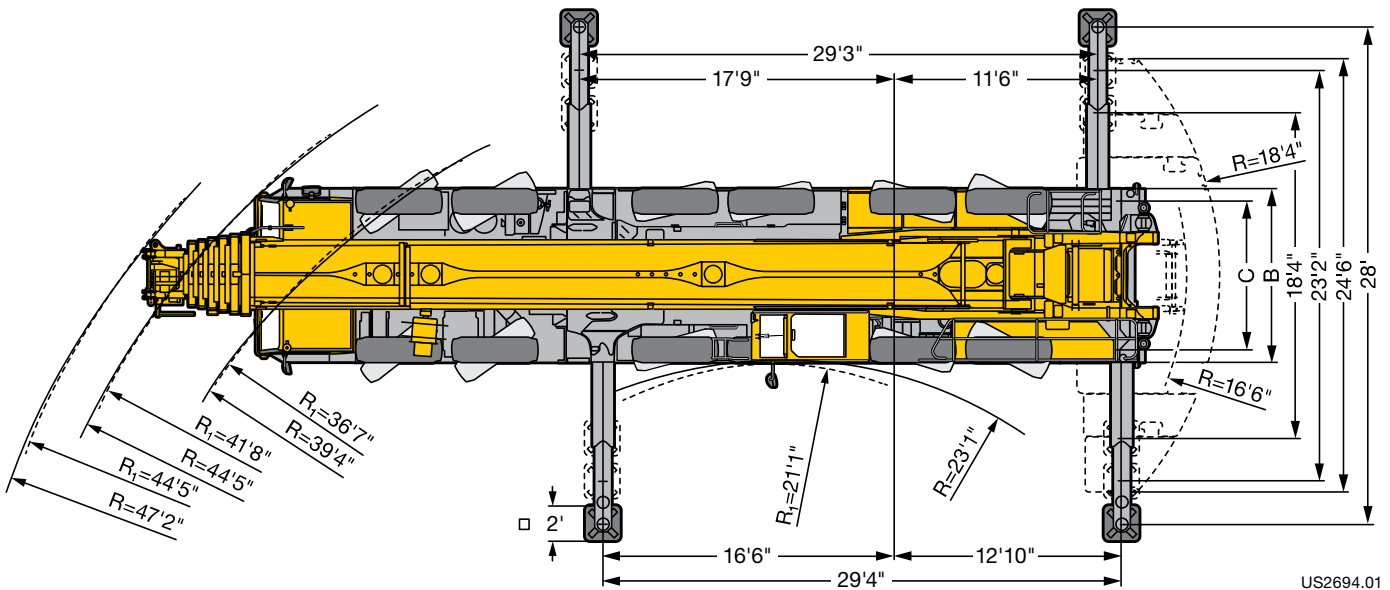
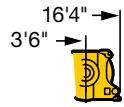
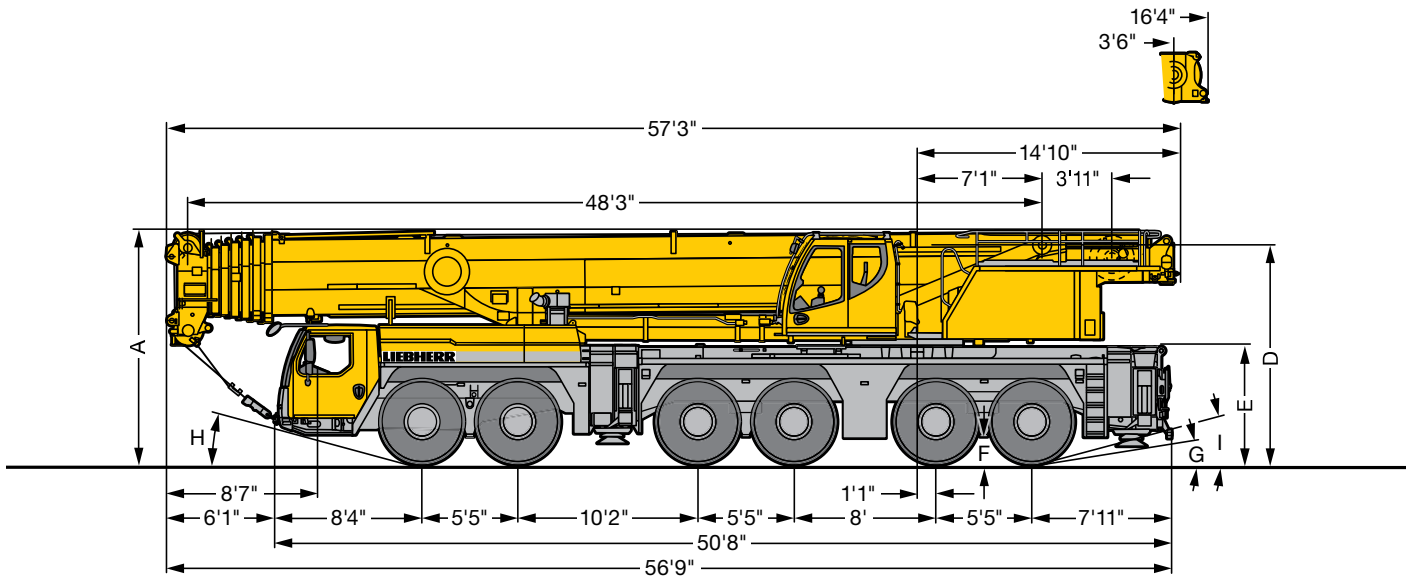

US2694.01

R₁ = All-wheel steering · Direction toutes roues

Dimensions · Encombrement										
	A	A 5"	B	C	D	E	F	G	H	I
445/95 R 25 (16.00 R 25)	13'1"	12'9"	9'10"	8'4"	12'3"	6'7"	1'4"	14°	9°	15°
525/80 R 25 (20.5 R 25)	13'1"	12'9"	10'2"	8'5"	12'3"	6'7"	1'4"	14°	9°	15°

* lowered · abaissé

Boom/jib combinations Configurations de flèche

- T** Telescopic boom · Flèche télescopique
- K** Mechanical swing away jib
Fléchette pliante mécanique
- NZK** Hydraulic swing away jib
Fléchette pliante hydraulique
- F** Fixed lattice jib · Fléchette treillis fixe
- N** Luffing fly jib
Fléchette treillis à volée variable



T

8 – 14

TK/TNZK

15 – 48

TF

49 – 58

TN

59 – 75



S2729



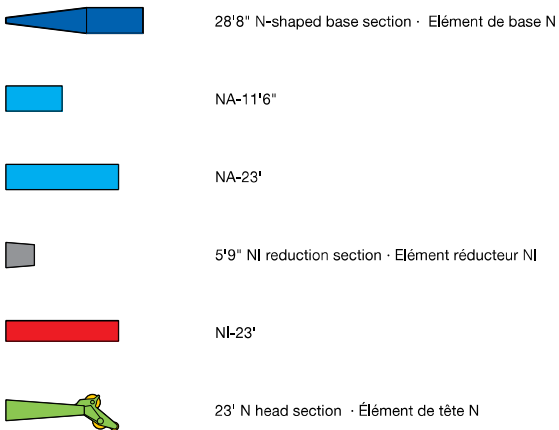
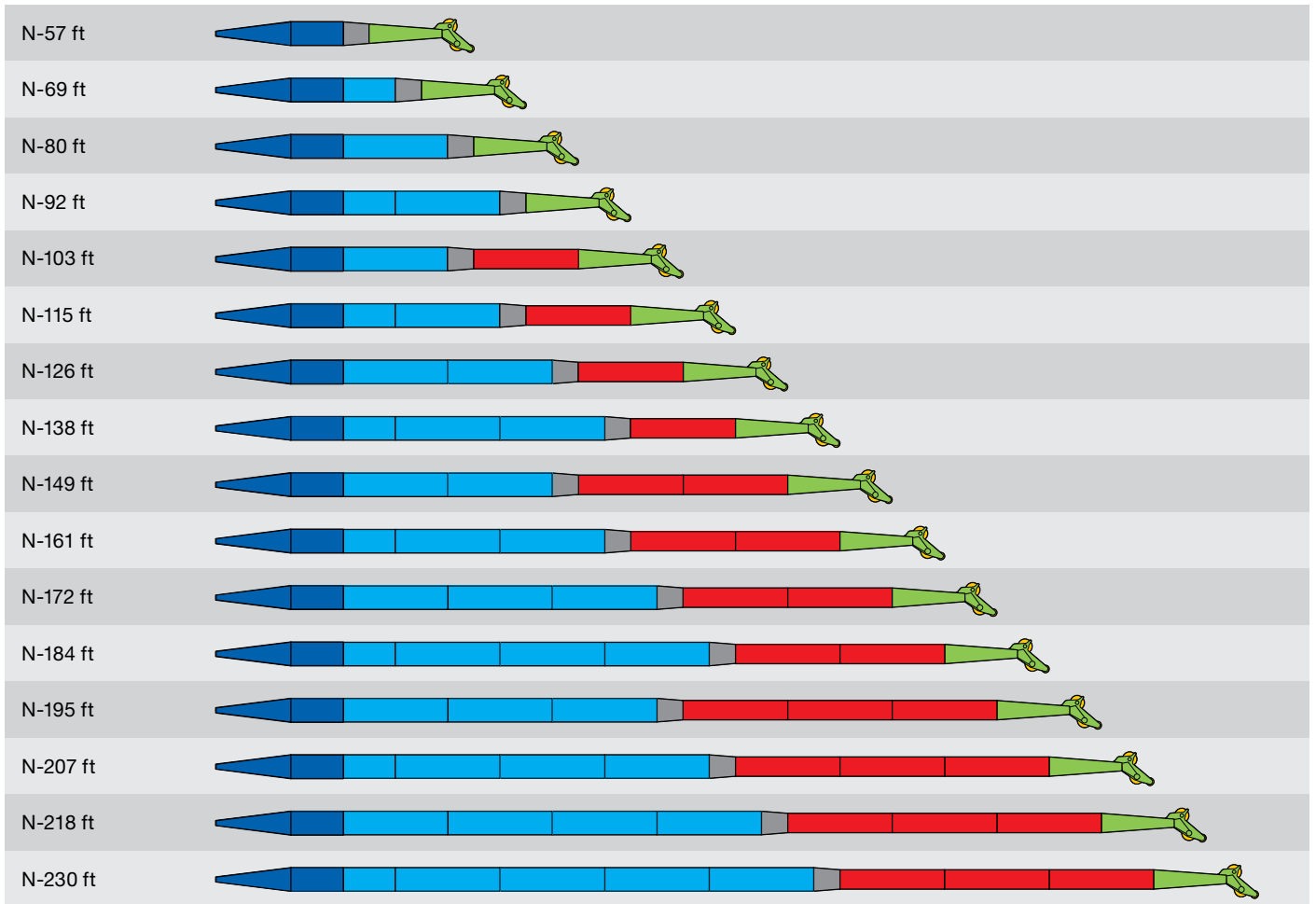



Boom/jib combinations - Luffing fly jib Configurations de flèche - Fléchette à volée variable



US2750

Boom/jib combinations - Fixed fly jib Configurations de flèche - Fléchette fixe

F-46 ft	
F-57 ft	
F-69 ft	
F-80 ft	
F-92 ft	
F-103 ft	
F-115 ft	
F-126 ft	
F-138 ft	

-  17'3" N-shaped base section · Élément de base N
-  NA-23'
-  NA-11'6"
-  5'9" NI reduction section · Élément réducteur NI
-  NI-23'
-  23' N head section · Élément de tête N

US2749

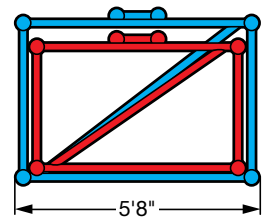
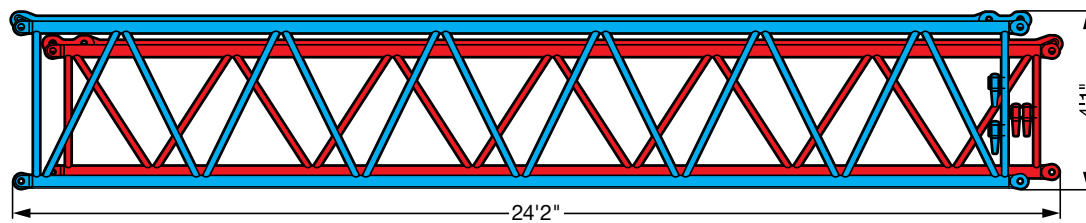

US2888

Weights Poids







Axle Essieu	1	2	3	4	5	6	Total weight lbs Poids total lbs
lbs	26400	26400	26400	26400	26400	26400	158400



Load kips Forces de levage kips	No. of sheaves Poulies	No. of lines Brins	Weight lbs Poids lbs
403.5	12	17	7500
343.3	7	14	3300
275.6	5	11	3530
176.4	3	7	3200
79.8	1	3	2200
27.1	–	1	1100

Working speeds Vitesses







	 min. МИН.	 max. МАКС.	 %
445/95 R 25 (16.00 R 25) 525/80 R 25 (20.5 R 25)	1.3	50	50.9 %







12 / R2



Drive Mécanismes	infinitely variable en continu	Rope diameter / length Diamètre / Longueur du câble	Max. single line pull Effort au brin maxi.
	0 – 427 ft/min single line ft/min au brin simple	0.9" / 984 ft	27420 lbs
	0 – 427 ft/min single line ft/min au brin simple	0.9" / 1525 ft	27420 lbs
	0 – 1.6 rpm		
	approx. 80 seconds to reach 82° boom angle env. 80 s jusqu'à 82°		
	approx. 800 seconds for boom extension from 48 ft – 256 ft env. 800 s pour passer de 48 ft – 256 ft		

Lifting capacities Forces de levage

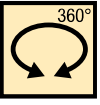
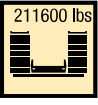
T

48 – 256 ft



85%

ft	ft																ft
	48 ft	64 ft	80 ft	96 ft	112 ft	128 ft	144 ft	160 ft	176 ft	192 ft	208 ft	224 ft	240 ft	253 ft	256 ft		
10	661.4	298.6														10	
11	504.2	298.6	298.6													11	
12	403.4	298.6	298.6	298.6												12	
13	385.2	298.6	298.6	298.6												13	
14	365.9	298.6	298.6	298.6												14	
15	349.7	298.6	298.6	298.6	248.3	191.2										15	
16	332.8	298.6	298.6	290.6	247.8	198.4										16	
17	318	297.3	296.2	279.6	246.7	198										17	
18	307.3	293.5	287.2	272.7	245.5	197.6										18	
19	297.7	284.4	278.8	264.2	244.2	197.1	159.8									19	
20	288.4	274.8	270.9	256.3	241.9	196.2	159.3									20	
22	271.3	256.4	257.1	241.9	230.3	194.3	158.3	130.2								22	
24	255	239.4	241.2	229.6	217.8	192.3	157.4	129.7								24	
26	235.7	223	225	218.6	206.8	190.4	156.4	129.2	102.1							26	
28	218.2	208.6	210.6	208	197	186.8	155.4	128.6	101.9							28	
30	202.9	195.8	197.7	197.6	188.3	182.4	154.4	128	101.6	82.1						30	
32	189.4	184.2	186.1	186.5	180.4	174.6	153.2	127.4	101.2	82						32	
34	177.5	173.3	175.3	175.9	172.7	167.5	151.9	126.8	100.9	81.8	66.1					34	
36	166.8	163.6	165.4	166.1	165.2	161.1	150.5	126.1	100.5	81.5	65.8					36	
38	156	154.6	156.5	157.2	156.6	155.1	147.1	125.1	99.1	81.1	65.6	54.1				38	
40	130.5	130.5	148	148.7	148.1	148.7	142.2	123.9	97.6	80.6	65.4	53.9				40	
45			130	130.1	132.1	131.7	129.4	120.6	92.3	78.6	64.6	53.4	43.6			45	
50			115.9	117.4	117.5	116.6	115.2	114.3	86.4	75.4	63.3	52.9	43.3	36.5	30.3	50	
55			96.1	105.1	105.2	104.3	104.9	104.3	81.2	71.2	61.2	52.1	42.5	36.1	30.1	29.3	55
60				94.8	94.8	93.9	96.1	94.5	76.2	67.3	58.4	50.5	41.5	35.4	29.9	29.2	60
65				85.7	85.7	84.7	86.9	85.4	71.5	63.5	55.5	48.5	40.4	34.6	29.4	28.8	65
70				74.2	77.9	78.8	79.1	77.6	67.3	59.8	52.8	46.5	39.1	33.7	28.8	28.4	70
75					71.1	73.3	72.3	70.8	63.3	56.2	50.1	44.5	37.8	32.7	28	27.7	75
80					65.3	67.4	66.4	64.8	59.6	53.1	47.5	42.6	36.5	31.6	27.1	26.8	80
85					60.7	62.2	61.2	59.6	56.2	50.1	45.1	40.6	35.3	30.5	26.3	26	85
90						57.6	56.6	55	52.8	47.3	42.9	38.7	34	29.5	25.4	25.2	90
95						53.6	52.5	50.9	49.3	44.9	40.7	36.9	32.8	28.6	24.6	24.4	95
100						49.3	48.8	47.2	45.7	42.5	38.6	35.2	31.6	27.6	23.8	23.6	100
105						25.6	45.5	43.9	43.4	40.1	36.8	33.6	30.5	26.7	23	22.9	105
110							42.5	40.9	41.9	38.1	34.9	32.1	29.3	25.7	22.3	22.2	110
115							39.5	38.1	39.7	36	33.1	30.6	28.2	25	21.5	21.5	115
120							27.2	36.9	37.2	33.6	31.5	29.2	27.1	24.2	20.9	20.8	120
125								35.9	34.9	32.1	30.1	27.9	26	23.4	20.2	20.2	125
130								34.3	32.7	30.7	28.6	26.5	25	22.6	19.6	19.6	130
135								24.2	30.7	28.7	27.1	25.4	23.9	22	19	19	135
140									28.9	26.9	25.4	24.2	22.9	21.3	18.4	18.4	140
145									27	25.9	24.3	23.1	22	20.6	17.8	17.7	145
150									21.8	25.2	23.3	22.1	21.1	20	17.3	17.1	150
155										24.7	22.4	21.1	20.2	19.3	16.7	16.5	155
160										23.4	21.1	19.8	19.3	18.6	16.2	15.8	160
165										18.6	19.8	19.1	18.5	17.9	15.6	15.2	165
170											19.1	18.4	17.8	17.2	15.1	14.6	170
175											18.7	17.8	16.9	16.5	14.6	14	175
180											15.3	17.1	16	15.9	14.2	13.3	180
185												16.2	15.5	15.3	13.7	12.7	185
190												15.3	15	14.6	13.2	12.2	190
195												13.2	14.6	13.9	12.8	11.6	195
200												5.4	14.2	13	12.3	11.1	200
205													13.5	12.2	11.9	10.6	205
210													10.3	11.4	11.4	10.1	210
215													4.7	10.7	10.9	9.6	215
220														9.9	10.2	9.2	220
225														7.2	9.5	8.7	225
230															8.8	8.3	230
235															7.6	7.9	235
240															4.8	5.9	240

* over rear - en arrière

L240_001_50001_00_000 / 001_50301_00_000

Lifting capacities Forces de levage

T

48 – 256 ft
±10°
211600 lbs
85%

ft	48 ft	64 ft	80 ft	96 ft	112 ft	128 ft	144 ft	160 ft	176 ft	192 ft	208 ft	224 ft	240 ft	253 ft	256 ft	ft	
10	298.6															10	
11	298.6	298.6														11	
12	298.6	298.6	298.6													12	
13	298.6	298.6	298.6													13	
14	298.6	298.6	298.6													14	
15	298.6	298.6	298.6	248.3	191.2											15	
16	298.6	298.6	290.6	247.8	198.4											16	
17	298.6	296.2	279.6	246.7	198											17	
18	298.6	287.2	272.7	245.5	197.6											18	
19	294.9	278.8	264.2	244.2	197.1	159.8										19	
20	288.4	270.9	256.3	241.9	196.2	159.3										20	
22	271.3	257.2	241.9	230.3	194.3	158.3	130.2									22	
24	255	242.8	229.6	217.8	192.3	157.4	129.7									24	
26	235.7	230.1	218.6	206.8	190.4	156.4	129.2	102.1								26	
28	218.2	218.3	208	197	186.8	155.4	128.6	101.9								28	
30	202.9	205.1	198	188.3	182.4	154.4	128	101.6	82.1							30	
32	189.4	191.5	188.9	180.4	174.6	153.2	127.4	101.2	82							32	
34	177.5	179.5	179.5	172.7	167.5	151.9	126.8	100.9	81.8	66.1						34	
36	166.8	168.7	169.5	165.2	161.1	150.5	126.1	100.5	81.5	65.8						36	
38	156	159.1	159.8	158.1	155.1	147.1	125.1	99.1	81.1	65.6	54.1					38	
40	130.5	150.5	151.1	150.6	149.2	142.2	123.9	97.6	80.6	65.4	53.9					40	
45		131.9	132.6	132.2	133.9	130.1	120.6	92.3	78.6	64.6	53.4	43.6				45	
50		118.4	117.6	119.9	119	117.7	115.2	86.4	75.4	63.3	52.9	43.3	36.5	30.3		50	
55		96.1	107.6	107.6	106.8	105.5	106.9	81.2	71.2	61.2	52.1	42.5	36.1	30.1	29.3	55	
60			97.3	97.4	96.5	98	97.1	76.2	67.3	58.4	50.5	41.5	35.4	29.9	29.2	60	
65			88.4	88.4	87.4	89.6	88.1	71.5	63.5	55.5	48.5	40.4	34.6	29.4	28.8	65	
70			74.2	80.6	79.6	81.8	80.3	67.3	59.8	52.8	46.5	39.1	33.7	28.8	28.4	70	
75				73.8	74	74.9	73.5	63.3	56.2	50.1	44.5	37.8	32.7	28	27.7	75	
80				68	69.8	69	67.5	59.6	53.1	47.5	42.6	36.5	31.6	27.1	26.8	80	
85				60.7	64.8	63.8	62.2	56.2	50.1	45.1	40.6	35.3	30.5	26.3	26	85	
90					60.2	59.1	57.6	52.8	47.3	42.9	38.7	34	29.5	25.4	25.2	90	
95					56.1	55	53.4	49.5	44.9	40.7	36.9	32.8	28.6	24.6	24.4	95	
100					49.3	51.3	49.7	46.9	42.5	38.6	35.2	31.6	27.6	23.8	23.6	100	
105					25.6	47.9	46.3	44.3	40.1	36.8	33.6	30.5	26.7	23	22.9	105	
110						44.9	43.2	41.9	38.1	34.9	32.1	29.3	25.7	22.3	22.2	110	
115						39.6	40.4	40.6	36.2	33.1	30.6	28.2	25	21.5	21.5	115	
120							27.2	37.9	39.2	34.4	31.5	29.2	27.1	24.2	20.9	20.8	120
125								35.9	37	32.7	30.1	27.9	26	23.4	20.2	20.2	125
130								34.7	34.9	31.1	28.6	26.5	25	22.6	19.6	19.6	130
135								24.2	32.9	29.3	27.2	25.4	23.9	22	19	19	135
140									31	27.9	26	24.2	22.9	21.3	18.4	18.4	140
145									27.5	26.8	24.8	23.1	22	20.6	17.8	17.7	145
150									21.8	25.6	23.6	22.1	21.1	20	17.3	17.1	150
155										24.7	22.6	21.1	20.2	19.3	16.7	16.5	155
160										24	21.6	20.2	19.3	18.6	16.2	15.8	160
165										18.6	20.8	19.3	18.5	17.9	15.6	15.2	165
170											20	18.5	17.8	17.2	15.1	14.6	170
175											18.7	17.8	17	16.5	14.6	14	175
180											15.3	17.2	16.3	15.9	14.2	13.3	180
185												16.6	15.6	15.3	13.7	12.7	185
190												15.7	15	14.6	13.2	12.2	190
195												13.2	14.6	14	12.8	11.6	195
200												5.4	14.2	13.5	12.3	11.1	200
205													13.7	13	11.9	10.6	205
210													10.3	12.5	11.4	10.1	210
215													4.7	11.8	11	9.6	215
220														10.3	10.6	9.2	220
225														7.2	10.2	8.7	225
230															9.6	8.3	230
235															7.6	7.9	235
240															4.8	5.9	240

t_240_001_50201_00_000

Lifting capacities Forces de levage

T

48 – 256 ft  123500 lbs **85%**





ft	48 ft	64 ft	80 ft	96 ft	112 ft	128 ft	144 ft	160 ft	176 ft	192 ft	208 ft	224 ft	240 ft	253 ft	256 ft	ft
10	298.6															10
11	298.6	298.6														11
12	298.6	298.6	298.6													12
13	298.6	298.6	298.6													13
14	298.6	298.6	298.6													14
15	298.6	298.6	298.6	248.3	191.2											15
16	298.6	298.6	290.6	247.8	198.4											16
17	294.7	296.2	279.6	246.7	198											17
18	283.8	284.5	272.7	245.5	197.6											18
19	272.1	272.9	264.2	244.2	197.1	159.8										19
20	260.7	262.7	256.3	241.9	196.2	159.3										20
22	239.6	241.8	241.8	230.3	194.3	158.3	130.2									22
24	220.5	222.6	223.1	217.7	192.3	157.4	129.7									24
26	202.5	204.9	205.8	204.4	190.4	156.4	129.2	102.1								26
28	187	189.3	190.1	189.2	186	155.4	128.6	101.9								28
30	173.4	176.4	176.2	178.5	173.9	154.4	128	101.6	82.1							30
32	160.9	164.8	166.5	166.7	162.4	152.7	127.4	101.2	82							32
34	149.3	153.3	155.1	155.4	152.1	145.3	126.8	100.9	81.8	66.1						34
36	139.1	142.9	144.9	144.8	143	136.7	126.1	100.5	81.5	65.8						36
38	130	133.8	135.7	135.9	134.6	131.9	124.2	99.1	81.1	65.6	54.1					38
40	121.9	125.7	127.4	127.6	126.6	126	120.3	97.6	80.6	65.4	53.9					40
45		108.4	110.2	110.2	111.7	110.3	104.3	92.3	78.6	64.6	53.4	43.6				45
50		93.2	95.2	96.8	98.1	96.2	90.7	85.3	75.4	63.3	52.9	43.3	36.5	30.3		50
55		79.9	81.9	85.1	84.8	83.7	79.6	75.8	70.9	61.2	52.1	42.5	36.1	30.1	29.3	55
60			73	74.1	73.8	72.7	70.9	67.8	63.7	58.4	50.5	41.5	35.4	29.9	29.2	60
65			64.4	65.2	64.9	63.7	62.5	61.4	58	54.3	48.5	40.4	34.6	29.4	28.8	65
70			57.2	57.9	57.6	56.5	56.5	56.5	52.6	48.8	46	39.1	33.7	28.8	28.4	70
75				51.8	51.5	50.3	52	50.6	47.3	45.9	42.7	37.8	32.7	28	27.7	75
80				46.7	46.3	46.8	47.2	45.4	42.7	41.8	38.6	36.5	31.6	27.1	26.8	80
85				42.4	41.9	43.9	42.7	40.9	39.9	37.9	36	34.3	30.5	26.3	26	85
90					38.6	40	38.8	37.5	37.7	34.5	34.1	31.7	29.5	25.4	25.2	90
95					36.9	36.6	35.4	34.3	34.7	32.7	31.6	29.1	28.5	24.6	24.4	95
100					34.2	33.7	32.4	32.8	31.7	30.9	28.9	28	27	23.8	23.6	100
105					25.6	31	30.1	30.7	29.1	29.4	27.1	26.5	25.1	23	22.9	105
110						28.6	28.3	28.3	27.2	27	25.9	24.7	23	22	22	110
115						26.5	27.2	26.2	26	24.8	24.4	22.8	21.1	20.6	20.3	115
120						24.7	25.4	24.2	24.4	22.9	22.9	21.1	19.4	19	18.7	120
125							23.6	22.3	22.6	22	21.2	19.5	17.8	17.4	17.1	125
130							22	21.5	20.8	20.6	19.4	18	16.3	16	15.7	130
135							20.5	20.5	19.2	19.1	17.8	16.6	14.9	14.7	14.4	135
140								19	18	17.6	16.4	15.3	13.6	13.4	13.1	140
145								17.7	16.7	16.2	15	14	12.4	12.3	12	145
150								16.6	15.5	15	13.8	12.8	11.3	11.2	10.9	150
155									14.4	13.9	12.6	11.6	10.1	10.2	9.9	155
160									13.4	12.8	11.5	10.5	9.1	9.2	8.9	160
165									12.4	11.8	10.6	9.5	8.1	8.3	8	165
170										10.9	9.6	8.6	7.1	7.4	7.2	170
175										10	8.8	7.7	6.2	6.5	6.3	175
180											9.2	7.9	6.9	5.4	5.7	180
185												7.2	6.1	4.7	4.7	185
190												6.5	5.4	3.9	4.2	190
195												5.8	4.7		3.5	195
200												5.2	4.1			200
205													3.5			205
210																210

t_240_001_00303_00_000

Lifting capacities Forces de levage

T

48 – 256 ft

85%

	48 ft	64 ft	80 ft	96 ft	112 ft	128 ft	144 ft	160 ft	176 ft	192 ft	208 ft	224 ft	240 ft	253 ft	256 ft	
10	298.6															10
11	298.6	298.6														11
12	298.6	298.6	298.6													12
13	298.6	298.6	298.6													13
14	298.6	298.6	298.6													14
15	298.6	298.6	298.6	248.3	191.2											15
16	298.6	298.6	290.6	247.8	198.4											16
17	298.6	296.2	279.6	246.7	198											17
18	298.6	287.2	272.7	245.5	197.6											18
19	285.3	278.8	264.2	244.2	197.1	159.8										19
20	271.2	268.7	256.3	241.9	196.2	159.3										20
22	246.1	248.5	241.9	230.3	194.3	158.3	130.2									22
24	225.1	227.3	227.2	217.8	192.3	157.4	129.7									24
26	206.9	209.2	210	206.6	190.4	156.4	129.2	102.1								26
28	191.4	193.6	194.3	193.5	186.8	155.4	128.6	101.9								28
30	177.8	179.9	180.5	180.7	179.5	154.4	128	101.6	82.1							30
32	165.8	168.6	168.4	170.3	168.3	153.2	127.4	101.2	82							32
34	154.9	158.5	159.6	160.2	158.2	148.7	126.8	100.9	81.8	66.1						34
36	144.9	148.6	150.3	150.3	148.8	140	126.1	100.5	81.5	65.8						36
38	136	139.6	141.4	141.5	138.9	132.1	124.8	99.1	81.1	65.6	54.1					38
40	127.8	131.5	133.2	133.3	129.9	127.1	121.1	97.6	80.6	65.4	53.9					40
45		110.4	112.8	112.8	113.1	110.5	104.5	92.3	78.6	64.6	53.4	43.6				45
50		93.2	95.2	96.8	98.2	96.4	91.4	85.8	75.4	63.3	52.9	43.3	36.5	30.3		50
55		79.9	81.9	85.1	84.8	83.8	80.5	76.5	71.2	61.2	52.1	42.5	36.1	30.1	29.3	55
60			73.2	74.4	74.1	73	71.1	69	64.9	58.4	50.5	41.5	35.4	29.9	29.2	60
65			65	65.8	65.4	64.3	63.1	61.8	58.5	54.7	48.5	40.4	34.6	29.4	28.8	65
70			57.9	58.7	58.3	57.3	56.7	57	53.8	50.1	46.4	39.1	33.7	28.8	28.4	70
75				52.7	52.3	51.2	52.5	51.5	48.6	45.9	44	37.8	32.7	28	27.7	75
80				47.7	47.2	46.8	48.1	46.4	44	42.8	39.9	36.5	31.6	27.1	26.8	80
85				43.4	42.9	44.5	43.6	41.9	40	39.2	36.3	35.1	30.5	26.3	26	85
90					39.1	41	39.8	38.4	37.7	35.8	34.5	33	29.5	25.4	25.2	90
95					37	37.6	36.4	35.2	35.8	32.7	32.9	30.2	28.6	24.6	24.4	95
100					35.2	34.6	33.4	32.9	32.7	31.1	30.2	28	27.6	23.8	23.6	100
105					25.6	32	30.8	31.4	30.1	29.6	27.8	26.9	26.1	23	22.9	105
110						29.6	28.7	29.3	27.8	28	26.1	25.8	24.2	22.3	22.1	110
115						27.5	27.2	27.2	26.1	25.8	25	24	22.3	21.5	21.2	115
120						25.7	26.2	25.2	25	23.8	23.7	22.2	20.5	20.1	19.8	120
125							24.6	23.4	23.6	22	22.2	20.6	18.9	18.6	18.2	125
130							23	21.7	21.8	21.1	20.4	19.1	17.4	17.1	16.8	130
135							21.5	20.7	20.2	20	18.8	17.7	16	15.8	15.4	135
140								19.9	18.8	18.6	17.4	16.3	14.7	14.5	14.2	140
145								18.7	17.4	17.2	16	15	13.5	13.3	13	145
150								17.5	16.4	15.9	14.7	13.7	12.2	12.2	11.9	150
155									15.3	14.8	13.6	12.5	11.1	11.2	10.9	155
160									14.2	13.7	12.5	11.5	10	10.2	9.9	160
165									13.3	12.7	11.5	10.4	9	9.2	9	165
170										11.7	10.5	9.5	8	8.3	8.1	170
175										10.9	9.6	8.6	7.1	7.4	7.2	175
180										10.1	8.8	7.8	6.3	6.5	6.3	180
185										8	7	5.5	5.8	5.5	5.5	185
190											7.3	6.2	4.8	5	4.8	190
195											6.6	5.6	4.1	4.3	4.1	195
200											5.4	4.9	3.4	3.6	3.4	200
205												4.3				205
210												3.7				210

t_240_001_00203_00_000

Lifting capacities Forces de levage

T

48 – 256 ft  101400 lbs **85%**

ft	48 ft	64 ft	80 ft	96 ft	112 ft	128 ft	144 ft	160 ft	176 ft	192 ft	208 ft	224 ft	240 ft	253 ft	256 ft	ft
10	298.6															10
11	298.6	298.6														11
12	298.6	298.6	298.6													12
13	298.6	298.6	298.6													13
14	298.6	298.6	298.6													14
15	298.6	298.6	298.6	248.3	191.2											15
16	297.4	298.5	290.6	247.8	198.4											16
17	291.7	291.9	279.6	246.7	198											17
18	278.6	279.1	272.7	245.5	197.6											18
19	266.3	267.7	264.2	244.2	197.1	159.8										19
20	254.5	256.7	255.4	241.9	196.2	159.3										20
22	232	234.6	234.7	229.8	194.3	158.3	130.2									22
24	211.7	214.2	214.6	212.1	192.3	157.4	129.7									24
26	194.3	196.7	197.6	196	189.4	156.4	129.2	102.1								26
28	178.8	182.7	182	184.5	176.8	155.4	128.6	101.9								28
30	164.3	168.5	170.2	170.1	164.3	153.3	128	101.6	82.1							30
32	151.7	155.8	157.4	157.9	152.9	144.8	127.4	101.2	82							32
34	140.6	144.6	146.5	146.7	141.3	137.9	126.8	100.9	81.8	66.1						34
36	130.9	134.8	136.7	136.6	131.1	129	120.6	100.5	81.5	65.8						36
38	122.1	126	128	128.1	125.3	120.1	112.7	99.1	81.1	65.6	54.1					38
40	113.4	117.7	119.7	119.7	118.7	112.1	105.2	96.5	80.6	65.4	53.9					40
45		97.1	99.5	102.8	101.1	95.5	89.7	85.8	78.6	64.6	53.4	43.6				45
50		82.2	85.2	86.5	86.1	82.8	78.3	74.2	70	63.3	52.9	43.3	36.5	30.3		50
55		69.8	72.9	73.9	73.6	72.1	69.7	67.1	63.2	58.9	52.1	42.5	36.1	30.1	29.3	55
60			63.1	64	63.7	62.6	62	60.4	55.9	53.4	49.4	41.5	35.4	29.9	29.2	60
65			55.2	56.1	55.7	55.5	56.7	53.8	50.3	48.2	44.2	40.4	34.6	29.4	28.8	65
70			48.8	49.6	49.2	51.2	50.2	48.1	45.9	42.9	40.7	38.9	33.7	28.8	28.4	70
75				44.2	44.9	45.9	44.8	43.5	42.5	39.7	38.1	35	32.7	28	27.7	75
80				39.6	41.8	41.3	40.1	39.2	39	36.6	34.5	32.7	31.4	27.1	26.8	80
85				35.8	37.8	37.3	36.8	36.9	35.3	34.2	32.3	30.7	29	26.2	26	85
90					34.4	33.9	33.6	33.7	32.4	31.4	30.3	28.4	26.5	25.2	24.7	90
95					31.4	30.9	31.7	30.6	30.8	28.7	28	25.8	24	23.5	23.1	95
100					28.8	28.2	29.1	28	28.1	27.2	25.6	23.6	21.8	21.3	20.9	100
105					25.6	26.9	26.7	26.5	25.8	25.6	23.5	21.5	19.8	19.4	19	105
110						25.2	24.6	24.7	23.6	23.5	21.6	19.7	18	17.6	17.2	110
115						23.3	22.7	22.8	21.9	21.4	19.8	17.9	16.3	16	15.6	115
120						21.6	21	21	20	19.6	18.2	16.4	14.8	14.5	14.2	120
125							19.4	19.3	18.4	17.9	16.6	15	13.3	13.1	12.7	125
130							17.9	17.8	16.8	16.3	15.1	13.6	12	11.8	11.5	130
135							16.6	16.4	15.4	14.9	13.7	12.4	10.8	10.6	10.3	135
140								15.1	14.1	13.7	12.4	11.3	9.7	9.5	9.2	140
145								13.9	12.9	12.5	11.2	10.2	8.6	8.5	8.2	145
150								12.9	11.9	11.3	10.1	9.1	7.6	7.5	7.2	150
155									10.9	10.3	9.1	8.1	6.6	6.6	6.3	155
160									10	9.4	8.1	7.1	5.7	5.8	5.5	160
165										9.1	8.5	7.3	6.2	5	4.7	165
170											7.7	6.4	5.4	4.2	3.8	170
175											6.9	5.7	4.6			175
180											6.2	5	3.9			180
185												4.3				185
190												3.7				190

t_240_001_00304_00_000

Lifting capacities Forces de levage

T

48 – 256 ft

±10°

101400 lbs

85%

ft	48 ft	64 ft	80 ft	96 ft	112 ft	128 ft	144 ft	160 ft	176 ft	192 ft	208 ft	224 ft	240 ft	253 ft	256 ft	ft
10	298.6															10
11	298.6	298.6														11
12	298.6	298.6	298.6													12
13	298.6	298.6	298.6													13
14	298.6	298.6	298.6													14
15	298.6	298.6	298.6	248.3	191.2											15
16	298.6	298.6	290.6	247.8	198.4											16
17	296.2	296.2	279.6	246.7	198											17
18	289.5	287.2	272.7	245.5	197.6											18
19	275.5	275.8	264.2	244.2	197.1	159.8										19
20	261.6	263.9	256.3	241.9	196.2	159.3										20
22	237.3	239.7	239.8	230.3	194.3	158.3	130.2									22
24	216.9	219.2	219.6	217.2	192.3	157.4	129.7									24
26	199.4	201.7	202.5	201.6	190.4	156.4	129.2	102.1								26
28	184.4	186.6	187.3	187.9	181.4	155.4	128.6	101.9								28
30	170.8	174.6	175.7	176	166.3	153.3	128	101.6	82.1							30
32	158.5	162.4	163.9	162.6	152.9	144.8	127.4	101.2	82							32
34	147.7	151.5	153.2	150.2	141.3	137.9	126.8	100.9	81.8	66.1						34
36	136.5	141.7	142.9	138.8	131.2	129.1	121	100.5	81.5	65.8						36
38	124	129.2	131.8	129.4	125.6	120.6	113.5	99.1	81.1	65.6	54.1					38
40	113.4	118.5	120.9	120.3	119.3	113	106.4	97.3	80.6	65.4	53.9					40
45		97.2	99.5	102.8	102	97	91.4	87.1	78.6	64.6	53.4	43.6				45
50		82.9	85.2	87	86.7	84.6	80	76.3	71.7	63.3	52.9	43.3	36.5	30.3		50
55		71	74	74.9	74.6	73.6	70.5	68.4	65.4	60.2	52.1	42.5	36.1	30.1	29.3	55
60			64.4	65.3	64.9	63.9	63.8	62.5	58	53.7	50.5	41.5	35.4	29.9	29.2	60
65			56.7	57.5	57.2	56.7	58.1	56	51.6	49.8	46.3	40.4	34.6	29.4	28.8	65
70			50.4	51.1	50.8	52	51.7	49.9	47.4	44.9	41.5	39.1	33.7	28.8	28.4	70
75				45.8	45.4	47.5	46.3	44.7	43.1	40.3	39.1	36.9	32.7	28	27.7	75
80				41.2	42.6	42.9	41.7	40.4	40.8	37.7	36.2	33.4	31.6	27.1	26.8	80
85				37.4	39.3	38.9	37.6	37.5	37	35.1	33.1	31.5	30.4	26.3	26	85
90					35.9	35.4	34.8	35.1	33.6	33	30.8	29.8	28.3	25.4	25.2	90
95					32.9	32.4	32.1	32.1	30.9	30.4	29.4	27.5	25.8	24.2	24.1	95
100					30.2	29.7	30.6	29.4	29.6	27.9	27.2	25.3	23.5	23	22.5	100
105					25.6	27.3	28.2	27	27.2	26.2	25.1	23.2	21.5	21	20.6	105
110						25.9	26	25.4	25.1	24.9	23.2	21.3	19.6	19.2	18.8	110
115						24.7	24	24.1	23.1	22.9	21.3	19.5	17.9	17.5	17.2	115
120						23	22.3	22.3	21.3	21	19.6	17.9	16.3	16	15.6	120
125							20.6	20.6	19.7	19.3	18.1	16.5	14.8	14.6	14.2	125
130							19.1	19.1	18.2	17.7	16.5	15.1	13.5	13.2	12.9	130
135							17.9	17.7	16.7	16.3	15	13.8	12.2	12	11.7	135
140								16.4	15.4	14.9	13.7	12.6	11.1	10.9	10.6	140
145								15.2	14.2	13.7	12.5	11.5	10	9.8	9.5	145
150								14.1	13.1	12.6	11.4	10.3	8.9	8.8	8.6	150
155									12	11.5	10.3	9.3	7.8	7.9	7.6	155
160									11.1	10.5	9.3	8.3	6.9	7	6.8	160
165									10.2	9.6	8.4	7.4	6	6.2	5.9	165
170										8.8	7.6	6.5	5.1	5.3	5.1	170
175										8	6.8	5.7	4.3	4.5	4.3	175
180										7.3	6	5	3.5	3.7	3.5	180
185											5.3	4.3				185
190											4.7	3.6				190
195											4.1					195
200											3.6					200

t_240_001_00204_00_000

Lifting heights Hauteurs de levage

T

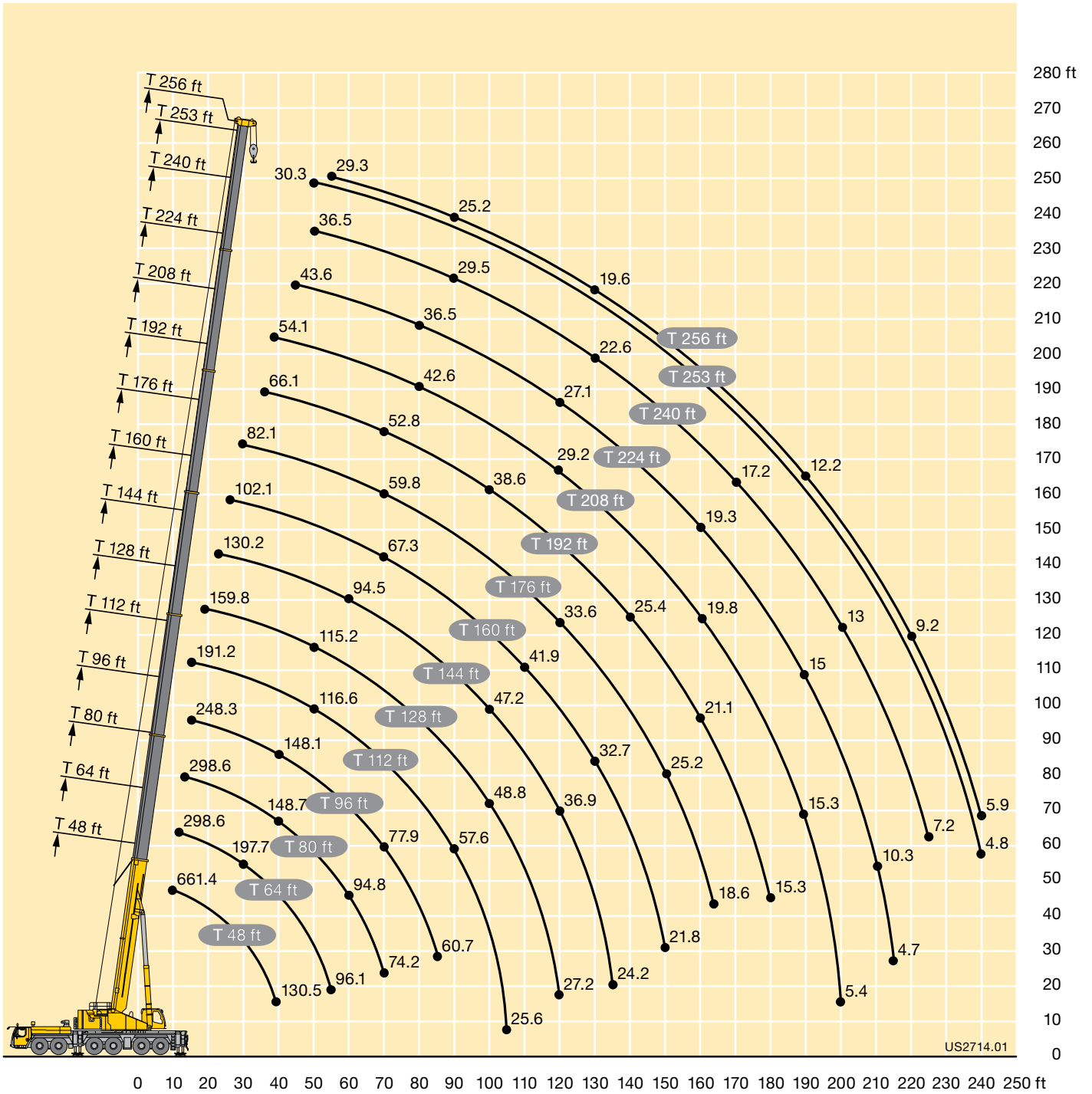

Lifting capacities Forces de levage

TK

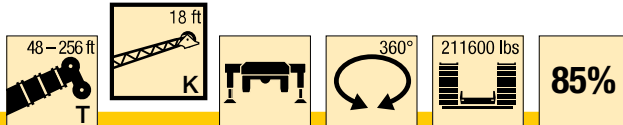

ft	48 ft			64 ft			80 ft			96 ft			112 ft			128 ft			144 ft			160 ft			ft
	18 ft			18 ft			18 ft			18 ft			18 ft			18 ft			18 ft			18 ft			
	0°	20°	40°	0°	20°	40°	0°	20°	40°	0°	20°	40°	0°	20°	40°	0°	20°	40°	0°	20°	40°	0°	20°	40°	
12	128.3	101.2																						12	
13	125.9	99.2	84.3	130.9	103																			13	
14	122.7	97.2	82.9	130.3	101.1		130.4																	14	
15	119.5	95.3	81.7	127.6	99.4	83.9	129.2	100.7																15	
16	116.3	93.5	80.5	124.9	97.8	82.8	127.4	99.6	126.8															16	
17	113.7	91.8	79.3	122.4	96.2	81.8	125.2	98.2	125.1															17	
18	111.2	90.1	78.2	120	94.7	80.8	123.1	96.8	81.8	123.4	97.5	121.2												18	
19	108.6	88.4	77.1	117.6	93.3	79.9	121	95.5	81	121.7	96.4	119.9												19	
20	106	86.9	76.1	115.2	91.9	78.9	119	94.2	80.2	120	95.3	118.6												20	
22	101.2	84	74	110.7	89.2	77.1	115.1	91.7	78.5	116.6	93	79.4	115.9	93.5	105.6									22	
24	96.9	81.1	72.2	106.7	86.4	75.3	111.2	89.2	77	113.1	90.8	77.9	113.1	91.5	78.3	105.6	91.1							24	
26	92.9	78.6	70.4	102.6	84.1	73.6	107.5	87	75.4	109.9	88.7	76.5	110.2	89.5	77	105.3	89.6	95.2						26	
28	89.1	76.1	68.8	98.8	81.8	72.2	104.2	84.8	74.1	106.9	86.7	75.2	107.5	87.6	75.8	104.7	88.2	76.8	94.7	83.6				28	
30	86	73.8	67.3	95.4	79.5	70.8	101.1	82.8	72.7	103.9	84.8	73.9	104.8	85.8	74.6	103.9	86.9	75.8	94.2	82.7	79.4			30	
32	82.8	71.9	65.9	92.3	77.5	69.4	98	81	71.4	100.9	83	72.8	102.4	84.2	73.5	102.4	85.6	74.8	93.4	81.7	73	79.4		32	
34	79.9	70.1	64.7	89.2	75.6	68.2	95.1	79.2	70.2	98.5	81.2	71.6	100.1	82.6	72.4	100.8	84.3	73.9	92.4	80.7	72.2	79.3	73.9	34	
36	77.4	68.3	63.6	86.5	73.8	67	92.4	77.5	69.1	96.1	79.6	70.5	97.8	81.1	71.4	99.1	83.1	73	91.5	79.8	71.4	79	73.3	67.7	36
38	74.9	66.7	62.6	84.1	72.1	65.9	89.9	75.9	68	93.7	78.2	69.5	95.6	79.7	70.5	97.4	81.8	72.2	90.4	78.8	70.7	78.6	72.7	67.2	38
40	72.6	65.2	61.7	81.7	70.7	64.9	87.6	74.3	67	91.4	76.8	68.5	93.6	78.2	69.5	95.7	80.6	71.3	89.3	77.9	69.9	78.2	72	66.6	40
45	67.9	62.2	60.1	76.3	67.2	62.7	82.3	70.8	64.8	86.3	73.3	66.3	88.9	75.2	67.4	91.6	77.6	69.4	86.3	75.4	68.2	76.5	70.2	65.2	45
50	64.1	59.9	59.4	71.7	64.3	60.9	77.7	67.9	62.9	81.8	70.4	64.3	84.4	72.3	65.5	88	75	67.5	83.1	73.2	66.6	73.6	67.9	63.7	50
55	60.5	58.2	9.1	68	61.9	59.7	73.7	65.2	61.2	78	67.8	62.6	80.7	69.7	63.7	84.3	72.5	66	78.7	71	65.1	69.8	65.1	61.7	55
60				64.7	59.9	32.6	70.2	63	59.9	74.4	65.6	61.2	77.2	67.3	62.2	81.2	70.2	64.4	73.8	69	63.8	66.1	62.3	59.3	60
65				62.2	58.8	16	67.2	61.1	58.9	71.2	63.4	59.9	74.2	65.3	60.9	78.2	68.3	63.1	69.1	66.9	62.6	62.5	59.9	57.1	65
70				59.3	57.5	9.5	64.5	59.6	47.6	68.4	61.7	59	71.4	63.5	59.8	74.8	66.5	61.9	64.9	64.3	61	59	57.5	55.1	70
75				41.9			62.3	58.4	22.2	65.9	60.1	58.1	68.9	61.7	58.8	68.5	64.9	60.9	60.9	60.6	58.8	55.6	55.1	53.1	75
80							60.5	57.8	13.8	63.9	58.9	57.8	64.2	60.4	58	62.6	63	60.1	57.1	56.9	56.4	52.7	52.5	51.1	80
85							58.2	55.9	9.2	60.2	57.8	29	59	59	57.4	57.3	57.9	58	53.7	53.6	53.6	49.8	49.8	49	85
90							40.8	13.5		55.6	55.9	18.1	54.4	54.8	55	52.7	53.3	53.5	51.4	50.4	50.5	47.2	47.2	46.9	90
95										51.5	51.8	12.5	50.2	50.6	37.1	48.6	49.1	49.3	49.3	47.1	47.4	44.9	44.8	44.8	95
100										47.9	44.9	9	46.6	46.9	22.6	44.9	45.3	45.5	46.2	45.1	44.3	42.6	42.6	42.6	100
105										35.8	15.6	5.7	43.3	43.5	15.8	43.1	41.9	40.7	42.9	43.1	42.9	40.3	40.4	40.5	105
110													40.3	40.5	11.7	41.4	40.2	27.7	39.9	40.2	40.4	38.2	38.2	38.3	110
115													37.6	37.7	8.9	38.9	39	19.2	37.1	37.4	37.6	35.5	35.9	36.1	115
120													31	17	6.3	36.4	36.6	14.4	34.6	34.9	32.4	33	33.3	33.5	120
125																34.1	34.3	11.2	32.3	32.5	22.8	31.3	31.4	31.5	125
130																32	32.1	8.8	30.2	30.4	17.2	29.5	29.8	29.9	130
135																25	18.2	6.6	28.2	28.3	13.5	27.5	27.7	26.7	135
140																			26.3	26.4	10.8	25.6	25.8	20.1	140
145																			24.6	24.7	8.7	23.8	24	15.8	145
150																			20.7	19	6.9	22.2	22.4	12.7	150
155																						20.7	20.9	10.5	155
160																						19.4	19.4	8.6	160
165																						16.4	16.4	7	165
170																						10.5	9.4		170

t_240_002_50001_00_000 / 52001_00_000 / 54001_00_000

Lifting capacities Forces de levage

TK

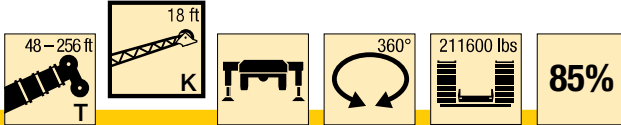

ft	176 ft			192 ft			208 ft			224 ft			240 ft			253 ft			256 ft			ft		
	18 ft			18 ft			18 ft			18 ft			18 ft			18 ft			18 ft					
	0°	20°	40°	0°	20°	40°	0°	20°	40°	0°	20°	40°	0°	20°	40°	0°	20°	40°	0°	20°	40°			
34	64.7																					34		
36	64.5																						36	
38	64.2	64.7		51.5																			38	
40	64	64.5		51.3																			40	
45	63.2	63.7	61	50.8	51.2	51.4	41.6																45	
50	62.2	62.8	60	50.3	50.7	51.2	41.2	41.5	42.2	34			25.4										50	
55	60.7	60.6	58.7	49.7	50	50.5	40.9	41.2	41.3	33.8	33.8	34.1	25.3	25.4		21				20.4			55	
60	57.9	57.8	56.7	48.7	48.8	49	40.3	40.1	40.2	33.2	33.2	33.5	25.1	25.2	25.1	21	21			20.4	20.4		60	
65	55	54.9	54.4	46.9	47	47.2	39.1	38.9	39	32.5	32.4	32.6	24.9	24.9	25	20.9	20.9	20.9		20.3	20.4	20.3	65	
70	52.2	52.2	52.1	44.9	45	45.3	37.9	37.9	37.7	31.6	31.4	31.5	24.6	24.5	24.6	20.7	20.7	20.8		20.2	20.3	20.3	70	
75	49.6	49.5	49.7	43	43.1	43.3	36.6	36.4	36.3	30.6	30.3	30.4	24.1	24	24.1	20.4	20.3	20.4		20	20	20.1	75	
80	46.9	47	47.1	41.1	41.1	41.4	35.3	35	34.9	29.5	29.3	29.3	23.5	23.4	23.5	19.9	19.9	19.9		19.6	19.6	19.6	80	
85	44.4	44.4	44.6	39.2	39.2	39.5	34	33.7	33.6	28.5	28.3	28.3	22.8	22.8	22.8	19.4	19.3	19.4		19.1	19.1	19.1	85	
90	42.1	42.1	42.3	37.3	37.4	37.6	32.7	32.4	32.3	27.5	27.3	27.3	22.2	22.1	22.2	18.8	18.7	18.8		18.6	18.5	18.5	90	
95	39.8	40	40.1	35.5	35.6	35.8	31.4	31.2	31.1	26.6	26.3	26.3	21.5	21.4	21.5	18.2	18.1	18.2		18	17.9	18	95	
100	37.7	37.8	38	33.8	33.9	34.1	30.1	30	29.9	25.6	25.4	25.4	20.9	20.7	20.8	17.6	17.5	17.6		17.4	17.4	17.4	100	
105	35.9	35.9	36	32.1	32.2	32.5	28.9	28.8	28.8	24.7	24.5	24.5	20.2	20.1	20.1	17	16.9	17		16.8	16.8	16.8	105	
110	34	34.2	34.3	30.6	30.6	30.9	27.6	27.6	27.6	23.7	23.6	23.6	19.5	19.4	19.5	16.5	16.4	16.4		16.3	16.2	16.3	110	
115	32.2	32.4	32.5	29.1	29.2	29.4	26.3	26.4	26.5	22.9	22.7	22.7	18.9	18.8	18.8	15.9	15.8	15.9		15.8	15.7	15.7	115	
120	30.6	30.7	30.8	27.7	27.8	28	25.1	25.2	25.3	22.1	21.9	21.9	18.2	18.1	18.2	15.4	15.3	15.4		15.3	15.2	15.2	120	
125	29.1	29.2	29.3	26.3	26.5	26.6	24	24	24.2	21.3	21.2	21.2	17.6	17.5	17.6	14.8	14.8	14.8		14.7	14.7	14.7	125	
130	27.7	27.7	27.9	25	25.2	25.3	22.9	23	23.1	20.5	20.4	20.4	17.1	17	17	14.3	14.3	14.3		14.3	14.2	14.2	130	
135	25.8	26.1	26.3	23.8	23.9	24	21.8	22	22.1	19.7	19.6	19.7	16.5	16.4	16.5	13.8	13.8	13.8		13.8	13.7	13.8	135	
140	23.9	24.2	24.4	22.7	22.8	22.9	20.8	20.9	21	19	18.9	19	15.9	15.9	15.9	13.4	13.4	13.4		13.3	13.3	13.3	140	
145	22.9	22.9	23	21.5	21.7	21.8	19.8	19.9	20	18.2	18.2	18.3	15.4	15.4	15.4	12.9	12.9	12.9		12.9	12.8	12.9	145	
150	21.9	21.9	22	20.5	20.6	20.7	18.9	19	19.1	17.5	17.5	17.6	15	14.9	14.9	12.5	12.5	12.5		12.4	12.4	12.4	150	
155	20.6	20.8	18.2	19.2	19.5	19.6	17.9	18.1	18.2	16.7	16.8	16.9	14.5	14.4	14.5	12.1	12.1	12.1		12	12	12	155	
160	19.2	19.3	14.7	17.8	18.1	18.1	17.1	17.2	17.3	16	16.1	16.2	14	14	14	11.7	11.7	11.7		11.7	11.6	11.7	160	
165	17.8	18	12.2	17	17.1	17.1	16.2	16.3	16.4	15.3	15.4	15.4	13.6	13.5	13.6	11.3	11.3	11.3		11.3	11.3	11.3	165	
170	16.6	16.7	10.2	16.3	16.3	16.4	15.4	15.6	15.6	14.6	14.6	14.7	13.1	13.1	13.1	10.9	10.9	11		10.9	10.9	10.9	170	
175	15.5	15.6	8.6	15.7	15.7	13.9	14.5	14.7	14.7	13.8	13.9	14	12.7	12.7	12.7	10.6	10.6	10.6		10.6	10.6	10.6	175	
180	13.1	13.2	7.1	14.8	14.9	11.8	13.5	13.5	13.6	13.2	13.3	13.3	12.3	12.3	12.3	10.2	10.2	10.2		10.2	10.2	10.2	180	
185		9.3	9.1	13.8	13.9	10	12.9	12.9	13	12.6	12.7	12.7	11.9	11.9	11.9	9.8	9.8	9.9		9.7	9.8	9.8	185	
190				12.8	12.9	8.6	12.4	12.5	12.5	11.4	11.4	11.5	11.5	11.5	11.6	9.5	9.5	9.5		9.2	9.3	9.3	190	
195				10.7	10.7	7.2	11.9	12	11.4	10.9	11	11	11	11	11.1	9.1	9.1	9.2		8.8	8.8	8.9	195	
200				7.7	7.7	5.1	11.4	11.4	9.9	9.4	9.7	9.8	10.5	10.6	10.6	8.8	8.8	8.9		8.3	8.4	8.4	200	
205							9.8	9.9	8.5	7.5	7.9	7.8	10	10.1	10.1	8.5	8.5	8.5		7.9	7.9	8	205	
210							8.8	8.8	7.3	5.7	6	6	9.5	9.6	9.6	8.1	8.2	8.2		7.5	7.5	7.5	210	
215							5.7	5.8	4.2	4	4.3	4.2	8.8	8.9	8.9	7.8	7.9	7.9		7.1	7.1	7.1	215	
220										2.4	2.6	2.3	8.1	8.2	8.2	7.5	7.6	7.6		6.7	6.7	6.7	220	
225													7.4	7.5	7.5	7.2	7.2	7.3		6.3	6.3	6.3	225	
230													6.9	6.9	6.9	6.9	7	7		5.9	5.9	6	230	
235													6.4	6.4	6.4	6.5	6.5	6.5		5.6	5.6	5.6	235	
240													4.6	4.8	4.3	5.9	6	6		5.2	5.2	5.2	240	
245																5.3	5.3	5.3		4.9	4.8	4.8	245	
250																4.4	4.6	4.3		4.4	4.4	4.4	250	
255																	2.1				2.8	3	2.6	255

t_240_002_50001_00_000 / 52001_00_000 / 54001_00_000

Lifting capacities Forces de levage

TK

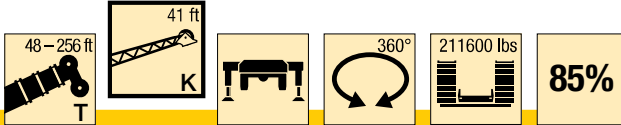

ft	48 ft			144 ft			160 ft			176 ft			192 ft			ft
	41 ft			41 ft			41 ft			41 ft			41 ft			
	0°	20°	40°	0°	20°	40°	0°	20°	40°	0°	20°	40°	0°	20°	40°	
12	52.4															12
13	52.1															13
14	51.7															14
15	51.2															15
16	50.7															16
17	50.1															17
18	49.5															18
19	48.9	39.2														19
20	48.3	39														20
22	47.1	37.2														22
24	45.8	35.3		52.7												24
26	44.3	33.6		52.8												26
28	42.9	32.1	23.1	52.8			47.4									28
30	41.4	30.8	22.8	52.6			47.4									30
32	40.1	29.5	22.1	52.4			47.4			41.7						32
34	38.8	28.5	21.6	52			47.3			41.6						34
36	37.5	27.4	21.1	51.6			47.1			41.6			35.6			36
38	36.3	26.4	20.6	51.2	38.4		46.7			41.5			35.7			38
40	34.9	25.6	20.2	50.7	37.5		46.3			41.3			35.7			40
45	31.2	23.6	19.2	49.3	35.2	23.1	45.4	36.1		40.7			35.5			45
50	28	22.1	18.4	47.8	33.3	22.3	44.5	34.1	22.5	40.1	34.5		35.2			50
55	25.4	20.8	17.8	46.3	31.6	21.7	43.5	32.3	21.9	39.5	32.9	22	34.8	31.8		55
60	23.4	19.6	17.4	44.6	30	21.1	42.6	30.8	21.3	38.8	31.3	21.4	34.4	31	21.5	60
65	21.6	18.7	17.1	42.8	28.7	20.6	41.4	29.5	20.8	38.2	29.9	20.9	34	30.1	20.9	65
70	20.1	18	17.1	41.1	27.5	20.1	40.1	28.3	20.3	37.5	28.7	20.5	33.6	28.8	20.5	70
75	18.8	17.6	16.3	39.5	26.4	19.6	38.8	27.2	19.9	36.7	27.5	20	33.1	27.7	20.1	75
80	17.8	17.5		38	25.4	19.2	37.6	26.2	19.5	35.8	26.6	19.7	32.7	26.7	19.7	80
85				36.5	24.5	18.9	36.4	25.2	19.1	34.9	25.7	19.3	32	25.8	19.4	85
90				34.8	23.6	18.6	35.2	24.4	18.8	34	24.8	19	31.4	25	19.1	90
95				33	22.9	18.3	34.1	23.6	18.5	33.1	24	18.7	30.7	24.3	18.8	95
100				31.3	22.2	18	32.9	22.9	18.2	32.3	23.3	18.4	29.9	23.5	18.5	100
105				29.6	21.5	17.8	31.4	22.3	18	31.5	22.7	18.1	29	22.9	18.2	105
110				28.2	20.9	17.6	30	21.6	17.8	30.5	22.1	17.9	27.8	22.3	18	110
115				26.9	20.4	17.4	28.6	21	17.6	29.4	21.5	17.7	26.5	21.7	17.8	115
120				25.7	19.9	17.3	27.3	20.6	17.4	28.2	21	17.5	25.4	21.1	17.6	120
125				24.6	19.4	17.2	26.3	20.1	17.3	27	20.5	17.4	24.3	20.7	17.4	125
130				23.7	19	17.1	25.2	19.6	17.1	25.9	20.1	17.2	23.2	20.3	17.3	130
135				22.8	18.6	17.1	24.2	19.2	17.1	24.7	19.7	17.2	22.2	19.9	17.2	135
140				21.9	18.3	17.1	23.3	18.9	17	23.6	19.3	17.1	21.2	19.5	17.1	140
145				21.1	18	15.7	22.6	18.6	17	22.6	18.9	17	20.2	19.1	17.1	145
150				20.4	17.8	10.1	21.8	18.2	17	21.5	18.6	17	19.3	18.7	17	150
155				19.7	17.6	7.2	21	18	16.5	20.4	18.4	17	18.4	18.3	17	155
160				19.1	17.5	5.4	20.4	17.8	12.4	19	18.1	17	17.5	17.8	16.8	160
165				18.6	17.5		19.4	17.6	8.7	17.7	17.8	17	16.7	17.1	16.6	165
170				17.2	16		18.1	17.5	6.6	17	17.1	15.1	16	16.4	16.4	170
175				10.2	6.9		17	17.4	5.1	16.3	16.5	10.5	15	15.6	15.8	175
180							15.9	16.3		15.5	15.8	7.8	14	14.7	15	180
185							13.3	15.2		14.5	15	6.1	13.1	13.6	12.2	185
190							7.7	7.5		13.6	14	4.9	12.6	12.7	9.1	190
195										12.7	13		12.1	12.2	7.2	195
200										10.4	12.1		11.6	11.7	5.8	200
205										6.1	7.8		11	11.3		205
210													10.3	10.6		210
215													8.3	9.8		215
220													7.1	7.2		220

t_240_002_50101_00_000 / 52101_00_000 / 54101_00_000

Lifting capacities Forces de levage

TK

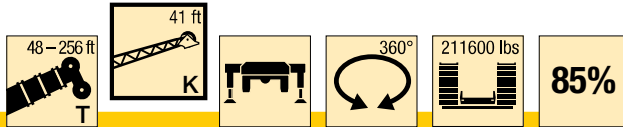

ft	208 ft			224 ft			240 ft			253 ft			256 ft			ft
	41 ft			41 ft			41 ft			41 ft			41 ft			
	0°	20°	40°	0°	20°	40°	0°	20°	40°	0°	20°	40°	0°	20°	40°	
45	30			23.3												45
50	30.1			23.5			19.4									50
55	29.9			23.6			19.4			16.4			15.9			55
60	29.7	28.3		23.8			19.4			16.4			15.9			60
65	29.5	27.8	20.9	23.9	23.9		19.3			16.4			16			65
70	29.3	27.3	22.6	23.8	23.7		19.2	19.2		16.3			15.9			70
75	28.9	26.9	22	23.6	23.3	22.5	19.1	18.8		16.1	16		15.8	15.7		75
80	28.5	26.4	21.5	23.2	22.8	22.1	18.9	18.4	17.8	15.9	15.8		15.6	15.5		80
85	28.1	25.6	21.1	22.6	22.3	21.6	18.7	17.9	17.4	15.7	15.5	15.1	15.4	15.2	15	85
90	27.4	24.8	20.8	22.1	21.7	21.2	18.2	17.5	16.9	15.5	15.1	14.7	15.2	15	14.6	90
95	26.7	24.1	20.5	21.5	21.1	20.7	17.9	17	16.4	15.1	14.8	14.4	14.9	14.6	14.2	95
100	25.8	23.4	20.2	20.8	20.4	20.3	17.4	16.6	16	14.7	14.4	14	14.5	14.3	13.9	100
105	24.9	22.8	19.9	20.2	19.8	19.7	17	16.1	15.6	14.3	14.1	13.7	14.1	13.9	13.6	105
110	24	22.2	19.4	19.5	19.1	19.1	16.5	15.7	15.2	13.9	13.7	13.4	13.8	13.6	13.3	110
115	23.2	21.7	18.8	18.9	18.5	18.5	16.1	15.3	14.9	13.5	13.3	13	13.4	13.2	12.9	115
120	22.4	21.1	18.2	18.2	17.9	17.9	15.6	14.9	14.5	13.1	12.9	12.7	12.9	12.8	12.6	120
125	21.5	20.7	17.6	17.6	17.3	17.3	15.1	14.6	14.2	12.6	12.5	12.4	12.5	12.4	12.3	125
130	20.7	20.1	17.3	17	16.8	16.7	14.6	4.2	13.9	12.2	12.1	12.1	12.1	12	12.1	130
135	19.9	19.6	17.2	16.4	16.2	16.2	14.1	13.8	13.5	11.8	11.7	11.8	11.7	11.6	11.7	135
140	19.1	19	17.1	15.9	15.7	15.7	13.7	13.4	13.2	11.4	11.3	11.4	11.3	11.2	11.4	140
145	18.3	18.3	17.1	15.4	15.2	15.2	13.2	13	12.9	11	10.9	11	10.9	10.9	11	145
150	17.5	17.7	17	14.9	14.7	14.7	12.8	12.7	12.6	10.6	10.6	10.7	10.6	10.5	10.6	150
155	16.7	17.1	16.8	14.4	14.3	14.3	12.4	12.3	12.3	10.3	10.2	10.3	10.2	10.2	10.3	155
160	16	16.4	16.3	13.9	13.8	13.8	12	11.9	12	9.9	9.9	10	9.8	9.8	9.9	160
165	15.3	15.6	15.7	13.5	13.3	13.4	11.6	11.6	11.6	9.6	9.5	9.6	9.5	9.5	9.6	165
170	14.6	14.9	15.2	13	12.9	13	11.2	11.2	11.3	9.2	9.2	9.3	9.2	9.2	9.3	170
175	13.9	14.2	14.5	12.5	12.5	12.6	10.9	10.8	10.9	8.9	8.9	9	8.9	8.9	9	175
180	13.2	13.6	13.9	12.1	12.1	12.2	10.5	10.5	10.6	8.6	8.6	8.7	8.6	8.6	8.7	180
185	12.6	13	13.2	11.6	11.7	11.8	10.2	10.2	10.3	8.3	8.3	8.4	8.3	8.3	8.4	185
190	12	12.3	12.6	11.1	11.3	11.5	9.8	9.8	9.9	8	8	8.1	8	8	8.1	190
195	11.2	11.7	11.9	10.7	10.9	11.1	9.5	9.5	9.6	7.8	7.8	7.9	7.7	7.8	7.9	195
200	10.3	11	10.7	10.2	10.4	10.7	9.2	9.2	9.3	7.5	7.5	7.6	7.4	7.5	7.6	200
205	9.8	10.1	8.3	9.7	10	10.2	8.9	8.9	9	7.3	7.3	7.4	7.1	7.3	7.4	205
210	9.5	9.5	6.7	9.2	9.5	9.7	8.6	8.7	8.8	7.1	7	7.1	6.8	7.1	7.1	210
215	9.1	9.2	5.5	8.7	9	9.2	8.3	8.4	8.5	6.8	6.8	6.9	6.5	6.8	6.8	215
220	8.7	8.8		7.9	8.4	7.6	7.9	8.1	8.2	6.6	6.6	6.7	6.2	6.4	6.5	220
225	8.4	8.5		7.6	7.7	6.3	7.6	7.8	7.9	6.4	6.4	6.5	5.9	6.1	6.2	225
230	7	8.2		7.4	7.4	5.3	7.2	7.5	7.6	6.2	6.2	6.3	5.5	5.7	5.9	230
235	5.6	6.6		7.1	7.2		6.8	7.1	7	6	6	6.1	5.1	5.4	5.5	235
240				6.9	6.9		6.3	6.6	6	5.8	5.8	5.9	4.8	5	5.1	240
245				6.1	6.8		5.8	6.1	5.1	5.5	5.6	5.7	4.4	4.7	4.7	245
250				3.5	4.8		5.1	5.5		5.2	5.4	5.5	4.1	4.3	4.4	250
255							4.6	4.9		4.6	5	5.1	3.8	4	4	255
260							3.2	4.3		4	4.4		3.5	3.7	3.7	260
265										3.4	3.8		3.2	3.4		265
270										2.8	3.2		2.7	3		270
275														2.4		275

t_240_002_50101_00_000 / 52101_00_000 / 54101_00_000

Lifting capacities Forces de levage

TK

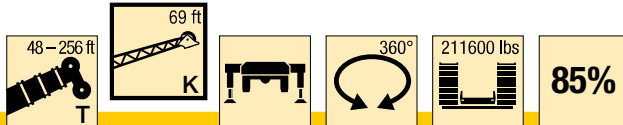

ft	48 ft			144 ft			160 ft			176 ft			192 ft			ft
	69 ft			69 ft			69 ft			69 ft			69 ft			
	0°	20°	40°	0°	20°	40°	0°	20°	40°	0°	20°	40°	0°	20°	40°	
12	20.8															12
13	20.8															13
14	20.9															14
15	21															15
16	21															16
17	21															17
18	21															18
19	21															19
20	21															20
22	21															22
24	20.9															24
26	20.7															26
28	20.5			20.8												28
30	20.3			20.9			19.9									30
32	20			21			19.9									32
34	19.7	17.8		21			19.9			18.7						34
36	19.4	17.5		21			19.9			18.7						36
38	19.1	17.2		21			19.9			18.8			17.4			38
40	18.7	16.9		21			19.9			18.8			17.4			40
45	17.9	16.1		21			19.9			18.8			17.5			45
50	17.1	15.4		20.8			19.9			18.8			17.5			50
55	16.3	14.7	13.2	20.5	17.5		19.8	17.2		18.8			17.5			55
60	15.5	14.1	12.8	20.3	17		19.6	16.8		18.7	16.3		17.5			60
65	14.8	13.6	12.4	19.9	16.7		19.3	16.4		18.5	16		17.3	15.2		65
70	14.2	13.1	12	19.5	16.2	13.4	19	16		18.2	15.6		17.1	15		70
75	13.6	12.6	11.8	19	15.8	13.2	18.6	15.6	13.1	17.9	15.3		16.8	14.7		75
80	13.1	12.3	11.6	18.6	15.4	13	18.2	15.3	12.9	17.6	15	12.7	16.6	14.4		80
85	12.6	12	11.4	18.1	15.1	12.8	17.8	15	12.7	17.2	14.7	12.5	16.3	14.2	12.2	85
90	12.1	11.7	11.4	17.7	14.7	12.6	17.4	14.6	12.5	16.9	14.4	12.3	16	13.9	12.1	90
95	11.6	11.5	11.4	17.2	14.4	12.4	17	14.3	12.3	16.5	14.1	12.2	15.7	13.7	11.9	95
100	11.1	11.4	11.4	16.7	14.1	12.2	16.6	14.1	12.2	16.2	13.9	12	15.4	13.4	11.8	100
105	10.6	11.3	4.5	16.3	13.8	12.1	16.2	13.8	12	15.8	13.6	11.9	15.1	13.2	11.7	105
110	9.8			15.9	13.5	11.9	15.8	13.5	11.9	15.5	13.4	11.7	14.9	13	11.5	110
115				15.5	13.3	11.8	15.5	13.3	11.8	15.2	13.1	11.6	14.6	12.8	11.4	115
120				15.1	13.1	11.7	15.1	13	11.6	14.9	12.9	11.5	14.4	12.6	11.3	120
125				14.7	12.8	11.6	14.8	12.8	11.5	14.6	12.7	11.4	14.1	12.4	11.2	125
130				14.4	12.6	11.5	14.4	12.6	11.4	14.3	12.5	11.4	13.9	12.3	11.1	130
135				14.1	12.4	11.4	14.1	12.4	11.4	14	12.3	11.3	13.6	12.1	11.1	135
140				13.7	12.2	11.4	13.8	12.3	11.3	13.8	12.2	11.2	13.4	11.9	11	140
145				13.4	12.1	11.4	13.6	12.1	11.3	13.5	12	11.2	13.2	11.8	11	145
150				13.1	11.9	11.4	13.3	11.9	11.2	13.2	11.9	11.1	13	11.7	10.9	150
155				12.9	11.8	11.4	13	11.8	11.2	13	11.7	11.1	12.8	11.5	10.9	155
160				12.6	11.7	11.4	12.8	11.7	11.2	12.8	11.6	11.1	12.6	11.4	10.8	160
165				12.3	11.6	11.4	12.5	11.6	11.2	12.5	11.5	11.1	12.4	11.3	10.8	165
170				12	11.5	11.4	12.3	11.5	11.2	12.3	11.4	11.1	12.2	11.2	10.8	170
175				11.8	11.5	11.4	12.1	11.4	11.2	12.1	11.3	11.1	12	11.1	10.8	175
180				11.5	11.4	8.6	11.8	11.3	11.2	12	11.2	11.1	11.8	11.1	10.8	180
185				11.2	11.3	6.2	11.6	11.3	11.2	11.8	11.2	11.1	11.7	11	10.8	185
190				10.9	11.3		11.4	11.3	10.3	11.6	11.1	11.1	11.5	10.9	10.8	190
195				10.6	11.3		11.2	11.2	7.6	11.4	11.1	11.1	11.2	10.9	10.8	195
200				10.2	10.7		11	11.2	5.8	11.3	11.1	11.1	11	10.9	10.8	200
205							10.8	11.2		11.1	11	9.1	10.7	10.9	10.8	205
210							10.5	11.2		10.9	11	7	10.1	10.6	10.8	210
215							7.7	10.6		10.7	10.9	5.4	9.4	10.2	10.3	215
220										10.1	10.7		9	9.4	8.2	220
225										8.8	9.9		8.7	8.8	6.4	225
230										6	8.1		8.3	8.5	5.2	230
235											3		8	8.2		235
240													7	7.9		240
245													5.2	6.5		245
250														5.2		250

t_240_002_50301_00_000 / 52301_00_000 / 54301_00_000

Lifting capacities Forces de levage

TK

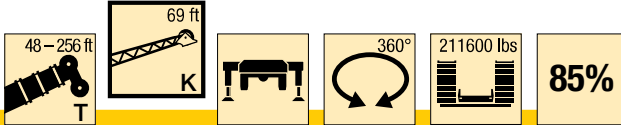

ft	208 ft			224 ft			240 ft			253 ft			256 ft			ft
	69 ft			69 ft			69 ft			69 ft			69 ft			
	0°	20°	40°	0°	20°	40°	0°	20°	40°	0°	20°	40°	0°	20°	40°	
45	15.8															45
50	15.9			14												50
55	15.9			14.1			12.2									55
60	15.8			14.1			12.2			10.6			10.4			60
65	15.7			14			12.2			10.6			10.4			65
70	15.6	14.1		14			12.2			10.7			10.4			70
75	15.5	13.9		13.8			12.1			10.7			10.5			75
80	15.2	13.6		13.7	12.6		12.1			10.7			10.4			80
85	15	13.4		13.6	12.5		12	11.3		10.6			10.4			85
90	14.8	13.2	11.7	13.4	12.3		11.9	11.2		10.6	10.2		10.4	10		90
95	14.6	13	11.5	13.2	12.1	11.1	11.8	11.1		10.5	10.1		10.3	9.9		95
100	14.4	12.8	11.4	13.1	12	11	11.7	11		10.4	10.1		10.3	9.9		100
105	14.2	12.6	11.3	13	11.9	10.9	11.6	10.9	10.3	10.4	10		10.2	9.8		105
110	14	12.4	11.2	12.8	11.7	10.8	11.5	10.8	10.3	10.3	9.9	9.6	10.1	9.8	9.5	110
115	13.8	12.3	11.1	12.7	11.6	10.7	11.4	10.7	10.2	10.2	9.8	9.5	10	9.7	9.4	115
120	13.6	12.1	11	12.5	11.5	10.6	11.2	10.6	10.1	10.1	9.6	9.4	10	9.5	9.3	120
125	13.4	12	11	12.4	11.4	10.6	11.1	10.5	10.1	10	9.4	9.2	9.9	9.4	9.1	125
130	13.2	11.8	10.9	12.2	11.2	10.5	10.9	10.4	10	9.8	9.2	8.9	9.7	9.1	8.9	130
135	13	11.7	10.8	12.1	11.1	10.5	10.8	10.2	9.9	9.5	9	8.7	9.4	8.9	8.7	135
140	12.8	11.5	10.8	11.9	11	10.5	10.6	10	9.7	9.2	8.7	8.5	9.2	8.7	8.5	140
145	12.6	11.4	10.7	11.8	10.9	10.4	10.4	9.8	9.5	9	8.5	8.3	8.9	8.5	8.3	145
150	12.4	11.3	10.7	11.6	10.8	10.4	10.2	9.5	9.3	8.7	8.3	8.1	8.7	8.3	8.1	150
155	12.2	11.2	10.7	11.5	10.7	10.4	10	9.3	9.1	8.5	8.1	7.9	8.4	8.1	7.9	155
160	12.1	11.1	10.6	11.3	10.6	10.3	9.7	9.1	8.9	8.2	7.9	7.8	8.2	7.9	7.8	160
165	11.9	11	10.6	11.1	10.5	10.3	9.5	8.9	8.8	8	7.7	7.6	7.9	7.7	7.6	165
170	11.8	10.9	10.6	10.8	10.4	10.3	9.2	8.7	8.6	7.7	7.6	7.5	7.7	7.5	7.5	170
175	11.6	10.9	10.6	10.5	10.2	10.3	8.9	8.5	8.4	7.4	7.4	7.3	7.4	7.4	7.3	175
180	11.4	10.8	10.6	10.2	10	10.2	8.7	8.3	8.2	7.2	7.2	7.2	7.2	7.2	7.2	180
185	11.1	10.7	10.6	9.9	9.8	10	8.5	8.1	8.1	7	7	7	6.9	7	7	185
190	10.8	10.7	10.6	9.6	9.6	9.8	8.2	8	7.9	6.8	6.8	6.9	6.7	6.8	6.9	190
195	10.6	10.6	10.6	9.3	9.3	9.6	7.9	7.8	7.8	6.6	6.7	6.8	6.5	6.6	6.7	195
200	10.3	10.5	10.6	9.1	9.1	9.3	7.7	7.6	7.6	6.4	6.5	6.6	6.3	6.4	6.6	200
205	9.9	10.2	10.5	8.8	8.8	9	7.5	7.5	7.5	6.2	6.3	6.4	6.2	6.2	6.4	205
210	9.5	9.8	10.2	8.5	8.5	8.7	7.3	7.3	7.4	6	6.1	6.2	6	6	6.2	210
215	9.1	9.5	9.9	8.2	8.3	8.5	7.1	7.1	7.2	5.8	5.9	6	5.8	5.9	6	215
220	8.6	9.1	9.4	7.9	8	8.2	6.9	6.9	7.1	5.6	5.7	5.9	5.6	5.7	5.8	220
225	7.9	8.7	8.9	7.6	7.7	8	6.7	6.8	6.9	5.5	5.5	5.7	5.3	5.5	5.7	225
230	7.3	8.1	8.4	7.3	7.5	7.7	6.5	6.6	6.8	5.3	5.4	5.5	5	5.3	5.5	230
235	7	7.5	7.5	6.9	7.2	7.4	6.3	6.4	6.6	5.1	5.2	5.4	4.7	5.2	5.3	235
240	6.8	7	6.1	6.5	6.9	7.1	6.1	6.3	6.4	5	5	5.2	4.5	5	5.1	240
245	6.6	6.7	5	6.1	6.6	6.8	5.9	6.1	6.2	4.8	4.9	5	4.2	4.7	4.8	245
250	6.4	6.5		5.7	6.2	6.3	5.7	5.9	6.1	4.6	4.7	4.9	3.9	4.4	4.5	250
255	5.7	6.2		5.5	5.7	5.7	5.4	5.7	5.9	4.4	4.6	4.7	3.6	4.1	4.2	255
260	4.9	5.4		5.4	5.4		4.9	5.4	5.6	4.2	4.4	4.5	3.3	3.7	3.9	260
265		3.4		5.2	5.3		4.4	5.1	5.3	4	4.2	4.4	3	3.4	3.5	265
270				4.7	5.1		3.9	4.5	4.6	3.7	4	4.1	2.7	3.1	3.2	270
275				2.8	4.5		3.3	3.9		3.3	3.8	3.9	2.4	2.8	2.9	275
280							2.8	3.4		2.5	3.4	3.5		2.5	2.5	280
285								2.8			2.9	2.9				285

t_240_002_50301_00_000 / 52301_00_000 / 54301_00_000

Lifting heights Hauteurs de levage

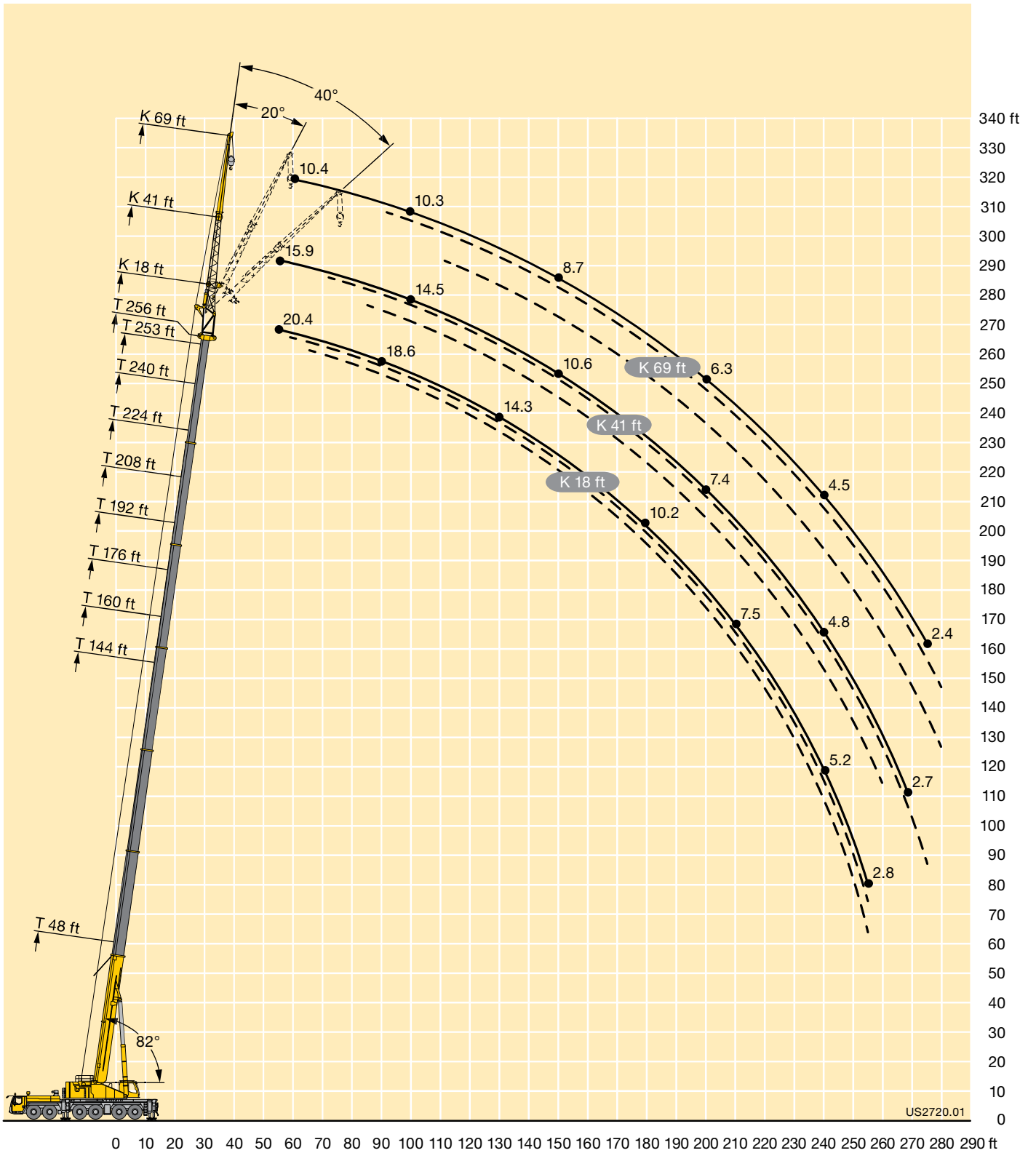

Lifting capacities Forces de levage

TK

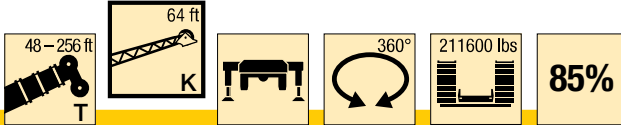

ft	48 ft			144 ft			160 ft			176 ft			192 ft			ft
	64 ft			64 ft			64 ft			64 ft			64 ft			
	0°	20°	40°	0°	20°	40°	0°	20°	40°	0°	20°	40°	0°	20°	40°	
12	31.4															12
13	31.4															13
14	31.4															14
15	31.4															15
16	31.2															16
17	31															17
18	30.7															18
19	30.5															19
20	30.2															20
22	29.6															22
24	29															24
26	28.4															26
28	27.7			31.4												28
30	27.1			31.4			27									30
32	26.4	22.9		31.4			27									32
34	25.8	22.3		31.3			27			24.9						34
36	25.2	21.6		31.1			27			24.9						36
38	24.6	21		30.9			27			24.9			22.1			38
40	24	20.4		30.6			27			25			22.1			40
45	22.6	19.1		29.8			27			25			22.1			45
50	21.2	17.9	15.1	29	22.7		26.9			25			22.2			50
55	19.7	16.9	14.3	28.1	21.8		26.7	22.3		24.7			22.1			55
60	18.2	16	13.7	27.3	21		26.1	21.7		24.3	20.9		21.9			60
65	16.9	15.2	13.1	26.4	20.3	15.4	25.5	21.2		23.9	20.4		21.6	19.3		65
70	15.6	14.5	12.6	25.6	19.6	15	25	20.6	15.9	23.4	19.9		21.3	18.9		70
75	14.5	13.8	12.2	24.8	18.9	14.6	24.3	20.1	15.7	23	19.5	15.5	21	18.6		75
80	13.6	13.2	11.9	24	18.3	14.3	23.7	19.6	15.4	22.5	19.1	15.2	20.7	18.2	14.9	80
85	12.7	12.7	11.7	23.2	17.8	14	23.1	19.1	15.1	22.1	18.7	14.9	20.4	17.9	14.6	85
90	11.9	12.2	11.6	22.4	17.2	13.7	22.5	18.6	14.8	21.6	18.2	14.7	20	17.5	14.4	90
95	11.3	11.8	11.6	21.7	16.7	13.4	21.9	18.1	14.5	21.1	17.8	14.4	19.7	17.2	14.2	95
100	10.7	11.6	5.1	20.9	16.2	13.1	21.4	17.6	14.3	20.7	17.4	14.2	19.4	16.8	14	100
105	10.3			20.1	15.8	12.9	20.8	17.1	14.1	20.2	17	14	19.1	16.5	13.8	105
110				19.3	15.4	12.7	20.3	16.7	13.9	19.8	16.6	13.8	18.8	16.2	13.6	110
115				18.5	15	12.5	19.8	16.3	13.7	19.4	16.2	13.6	18.4	15.9	13.4	115
120				17.7	14.7	12.3	19.3	15.9	13.5	18.9	15.9	13.4	18.1	15.5	13.2	120
125				17	14.3	12.1	18.8	15.6	13.3	18.5	15.6	13.3	17.8	15.2	13.1	125
130				16.3	14	12	18.3	15.3	13.2	18.1	15.2	13.1	17.5	15	13	130
135				15.6	13.7	11.9	17.8	14.9	13	17.7	15	13	17.2	14.7	12.8	135
140				15	13.4	11.8	17.3	14.6	12.9	17.3	14.7	12.9	16.8	14.4	12.8	140
145				14.5	13.1	11.7	16.9	14.3	12.8	16.9	14.4	12.8	16.5	14.2	12.7	145
150				14	12.9	11.7	16.4	14	12.8	16.5	14.1	12.7	16.2	14	12.6	150
155				13.5	12.6	11.6	15.9	13.8	12.7	16.1	13.9	12.7	15.8	13.7	12.5	155
160				13	12.3	11.6	15.4	13.5	12.6	15.7	13.6	12.6	15.5	13.5	12.5	160
165				12.5	12.1	11.6	14.9	13.3	12.6	15.3	13.3	12.6	15.1	13.3	12.4	165
170				12.1	12	11.6	14.4	13	12.6	14.9	13.1	12.5	14.7	13.1	12.4	170
175				11.8	11.8	8.6	13.9	12.8	12.6	14.5	12.9	12.5	14.2	12.9	12.3	175
180				11.4	11.7	6.3	13.5	12.6	12.6	14.1	12.7	12.5	13.8	12.7	12.3	180
185				11.1	11.6		13.1	12.5	10.6	13.7	12.5	12.4	13.3	12.5	12.3	185
190				10.8	11.6		12.7	12.3	7.6	13.3	12.4	12.4	12.7	12.2	12.3	190
195				10.5	11.1		12.3	12.3	5.8	12.8	12.3	11.8	12.2	12	12.3	195
200							12	12.2		12.4	12.2	9.1	11.3	11.8	12	200
205							11.5	12.2		11.9	11.9	7	10.5	11.4	11.6	205
210							8.2	10.9		11.2	11.5	5.5	9.7	10.6	10.6	210
215								3.8		10.5	11		9.4	9.7	8.2	215
220										9.3	10.2		9	9.2	6.5	220
225										6.3	8.4		8.7	8.8	5.2	225
230											3.4		8.3	8.5		230
235													7.4	8.1		235
240													5.4	6.8		240
245													4.1	5.4		245

t_240_002_50201_00_000 / 52201_00_000 / 54201_00_000

Lifting capacities Forces de levage

TK

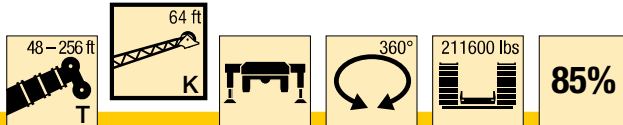

ft	208 ft			224 ft			240 ft			253 ft			256 ft			ft
	64 ft			64 ft			64 ft			64 ft			64 ft			
	0°	20°	40°	0°	20°	40°	0°	20°	40°	0°	20°	40°	0°	20°	40°	
45	19.2															45
50	19.2			16.4												50
55	19.3			16.4			13.8									55
60	19.2			16.4			13.9			11.9			11.6			60
65	19.1			16.4			13.9			11.9			11.6			65
70	18.9	17.5		16.4			13.9			12			11.7			70
75	18.7	17.2		16.3	15.5		13.9			12			11.7			75
80	18.5	17		16.2	15.4		13.8			11.8			11.6			80
85	18.3	16.7	14.2	16	15.2		13.7	13.2		11.7			11.5			85
90	18.1	16.5	14	15.9	15.1		13.6	13.2		11.6	11.2		11.4	10.9		90
95	17.9	16.2	13.8	15.7	14.9	13.1	13.5	13.1		11.5	11.2		11.3	10.9		95
100	17.7	15.9	13.6	15.6	14.8	13	13.3	12.9	12.1	11.4	11.1		11.2	10.8		100
105	17.4	15.7	13.4	15.4	14.6	12.9	13.2	12.6	12	11.2	10.9	10.5	11.1	10.7	10.4	105
110	17.2	15.4	13.2	15.2	14.4	12.7	13	12.2	11.7	11.1	10.6	10.2	10.9	10.5	10.2	110
115	17	15.2	13.1	15	14.2	12.6	12.8	11.9	11.4	10.9	10.3	10	10.7	10.2	9.9	115
120	16.8	14.9	13	14.8	14	12.5	12.5	11.6	11.2	10.7	10.1	9.7	10.6	10	9.7	120
125	16.6	14.7	12.8	14.6	13.8	12.4	12.2	11.3	10.9	10.5	9.8	9.5	10.4	9.7	9.4	125
130	16.3	14.4	12.7	14.3	13.6	12.3	11.8	11	10.6	10.2	9.6	9.3	10.1	9.5	9.2	130
135	16.1	14.2	12.6	14	13.4	12.2	11.5	10.7	10.4	9.9	9.3	9	9.8	9.2	9	135
140	15.9	14	12.5	13.7	13.2	12.2	11.2	10.5	10.1	9.6	9.1	8.8	9.5	9	8.8	140
145	15.6	13.8	12.4	13.2	12.9	12.1	10.9	10.2	9.9	9.3	8.9	8.6	9.2	8.8	8.6	145
150	15.2	13.6	12.4	12.8	12.6	12	10.6	9.9	9.7	9	8.6	8.4	8.9	8.6	8.4	150
155	14.8	13.4	12.3	12.4	12.2	11.9	10.4	9.7	9.5	8.7	8.4	8.2	8.6	8.4	8.2	155
160	14.3	13.1	12.2	12	11.8	11.7	10.1	9.5	9.2	8.4	8.2	8	8.3	8.2	8	160
165	13.9	12.9	12.2	11.6	11.5	11.5	9.8	9.2	9	8.1	8	7.8	8.1	7.9	7.8	165
170	13.4	12.7	12.1	11.2	11.1	11.2	9.5	9	8.9	7.8	7.8	7.7	7.8	7.7	7.7	170
175	13	12.5	12.1	10.9	10.8	10.9	9.2	8.8	8.7	7.5	7.5	7.5	7.5	7.5	7.5	175
180	12.5	12.2	12	10.5	10.5	10.6	9	8.6	8.5	7.2	7.3	7.3	7.2	7.3	7.3	180
185	12	11.9	11.9	10.1	10.1	10.3	8.7	8.4	8.3	7	7.1	7.2	7	7.1	7.1	185
190	11.4	11.6	11.7	9.8	9.8	10	8.4	8.2	8.2	6.8	6.9	7	6.8	6.9	7	190
195	10.9	11.3	11.6	9.5	9.5	9.7	8.1	8	8	6.6	6.7	6.8	6.6	6.7	6.8	195
200	10.4	10.9	11.1	9.2	9.2	9.4	7.8	7.9	7.9	6.4	6.5	6.6	6.4	6.5	6.6	200
205	10	10.4	10.7	8.9	8.9	9.1	7.6	7.6	7.7	6.2	6.3	6.4	6.2	6.3	6.4	205
210	9.5	9.9	10.2	8.6	8.6	8.8	7.4	7.4	7.5	6	6.1	6.2	6	6.1	6.2	210
215	8.9	9.5	9.7	8.3	8.3	8.6	7.2	7.2	7.3	5.8	5.9	6	5.8	5.9	6	215
220	8.3	9	9.2	7.9	8	8.3	7	7	7.1	5.7	5.7	5.9	5.5	5.7	5.9	220
225	7.6	8.4	8.6	7.6	7.7	8	6.7	6.8	6.9	5.5	5.5	5.7	5.2	5.5	5.7	225
230	7.3	7.7	7.5	7.2	7.4	7.7	6.5	6.6	6.8	5.3	5.4	5.5	4.9	5.3	5.5	230
235	7	7.1	6.1	6.8	7.1	7.3	6.3	6.4	6.6	5.2	5.2	5.3	4.6	5.1	5.3	235
240	6.8	6.9	5	6.3	6.8	7	6.1	6.3	6.4	5	5	5.2	4.3	4.8	5	240
245	6.6	6.6		5.9	6.3	6.5	5.8	6.1	6.2	4.8	4.9	5	4.1	4.5	4.7	245
250	6	6.4		5.7	5.8	5.8	5.6	5.9	6.1	4.6	4.7	4.9	3.8	4.2	4.4	250
255	5	5.6		5.5	5.6		5.1	5.6	5.8	4.4	4.6	4.7	3.5	3.8	4	255
260		3.6		5.4	5.4		4.6	5.3	5.4	4.1	4.4	4.5	3.2	3.5	3.7	260
265				4.9	5.3		4	4.7	4.8	3.8	4.1	4.3	2.9	3.2	3.3	265
270				3	4.6		3.5	4.1		3.3	3.9	4	2.6	2.9	3	270
275							3	3.5			3.5	3.6		2.6	2.6	275
280								2.9			2.5	2.6				280

t_240_002_50201_00_000 / 52201_00_000 / 54201_00_000

Lifting capacities Forces de levage

TK

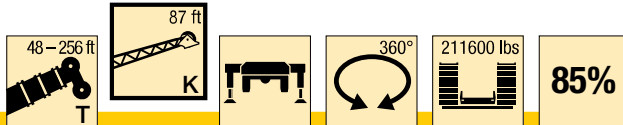

ft	48 ft			144 ft			160 ft			176 ft			192 ft			ft
	87 ft			87 ft			87 ft			87 ft			87 ft			
	0°	20°	40°	0°	20°	40°	0°	20°	40°	0°	20°	40°	0°	20°	40°	
14	19.4															14
15	19.4															15
16	19.4															16
17	19.4															17
18	19.4															18
19	19.5															19
20	19.4															20
22	19.3															22
24	19.1															24
26	18.9															26
28	18.5															28
30	18.2															30
32	17.8			19.4												32
34	17.5			19.4			18									34
36	17.1			19.5			18.1									36
38	16.8			19.5			18.1			16.5						38
40	16.4			19.4			18.1			16.6						40
45	15.6	13.5		19.2			18.1			16.6			14.9			45
50	14.8	12.7		18.8			17.8			16.5			15			50
55	14	11.9		18.3			17.5			16.4			14.9			55
60	13.1	11.2		17.8			17			16.1			14.7			60
65	12.4	10.6	8.9	17.2	13.4		16.6	13.1		15.7			14.5			65
70	11.6	10	8.5	16.7	12.9		16.2	12.7		15.4	12.4		14.3			70
75	10.9	9.5	8.1	16.2	12.4		15.8	12.3		15	12		14	11.6		75
80	10.3	9	7.8	15.7	12		15.3	11.9		14.7	11.7		13.7	11.3		80
85	9.7	8.5	7.5	15.2	11.5	8.7	14.9	11.5		14.3	11.3		13.4	11		85
90	9.1	8.2	7.3	14.8	11.1	8.5	14.5	11.1	8.5	14	11	8.4	13.2	10.7		90
95	8.6	7.8	7.1	14.3	10.8	8.3	14.1	10.8	8.3	13.6	10.7	8.2	12.9	10.4	8	95
100	8.2	7.5	6.9	13.8	10.5	8.1	13.7	10.5	8.1	13.3	10.4	8	12.6	10.1	7.9	100
105	7.8	7.3	6.8	13.3	10.1	8	13.3	10.2	7.9	13	10.1	7.9	12.3	9.8	7.8	105
110	7.3	7	6.8	12.9	9.8	7.8	12.9	9.9	7.8	12.6	9.8	7.7	12.1	9.6	7.6	110
115	7	6.9	6.8	12.4	9.5	7.6	12.5	9.6	7.6	12.3	9.6	7.6	11.8	9.3	7.5	115
120	6.7	6.8	6.8	12	9.3	7.5	12.1	9.3	7.5	12	9.3	7.5	11.5	9.1	7.4	120
125	6.5	6.8		11.5	9	7.4	11.7	9.1	7.4	11.6	9	7.3	11.3	8.9	7.3	125
130				11.1	8.8	7.3	11.4	8.8	7.3	11.3	8.8	7.2	11	8.7	7.2	130
135				10.7	8.5	7.2	11	8.6	7.2	11	8.6	7.1	10.7	8.5	7.1	135
140				10.3	8.3	7.1	10.6	8.4	7.1	10.7	8.4	7	10.4	8.3	7	140
145				10	8.1	7	10.2	8.2	7	10.4	8.2	7	10.2	8.2	6.9	145
150				9.6	7.9	6.9	9.9	8	6.9	10.1	8.1	6.9	9.9	8	6.8	150
155				9.3	7.8	6.9	9.6	7.9	6.9	9.8	7.9	6.8	9.7	7.8	6.8	155
160				9	7.6	6.8	9.3	7.7	6.8	9.5	7.7	6.8	9.4	7.7	6.7	160
165				8.8	7.4	6.8	9	7.6	6.8	9.2	7.6	6.7	9.2	7.5	6.7	165
170				8.5	7.3	6.8	8.8	7.4	6.8	9	7.4	6.7	8.9	7.4	6.6	170
175				8.2	7.2	6.8	8.5	7.3	6.7	8.7	7.3	6.7	8.7	7.3	6.6	175
180				7.9	7.1	6.8	8.3	7.2	6.7	8.5	7.2	6.6	8.5	7.2	6.6	180
185				7.7	7	6.8	8.1	7.1	6.7	8.2	7.1	6.6	8.3	7.1	6.6	185
190				7.5	6.9	6.8	7.9	7	6.7	8	7	6.6	8.1	7	6.5	190
195				7.2	6.9	6.8	7.6	6.9	6.7	7.9	6.9	6.6	7.9	6.9	6.5	195
200				7	6.8	6.8	7.4	6.8	6.7	7.7	6.9	6.6	7.7	6.8	6.5	200
205				6.9	6.8	5.4	7.3	6.8	6.7	7.5	6.8	6.6	7.6	6.8	6.5	205
210				6.7	6.8		7.1	6.8	6.7	7.4	6.7	6.6	7.5	6.7	6.5	210
215				6.6	6.8		6.9	6.8	6.5	7.2	6.7	6.6	7.3	6.7	6.5	215
220				6.1	6.8		6.8	6.8	5.1	7.1	6.7	6.6	7.2	6.6	6.5	220
225							6.6	6.8		6.9	6.7	6.6	7.1	6.6	6.5	225
230							6.5	6.8		6.8	6.6	6.2	6.9	6.6	6.5	230
235							4.4	6.6		6.6	6.6		6.8	6.6	6.5	235
240										6.6	6.6		6.7	6.6	6.5	240
245										5.7	6.6		6.6	6.6	5.9	245
250										2.8	5.1		6.5	6.5		250
255													6.2	6.4		255
260													4.4	6.2		260
265													3.9	4		265

t_240_002_50401_00_000 / 52401_00_000 / 54401_00_000

Lifting capacities Forces de levage

TK

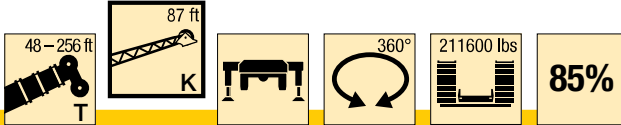

ft	208 ft			224 ft			240 ft			253 ft			256 ft			ft
	87 ft			87 ft			87 ft			87 ft			87 ft			
	0°	20°	40°	0°	20°	40°	0°	20°	40°	0°	20°	40°	0°	20°	40°	
50	13.1															50
55	13.1			11.2												55
60	13.1			11.3			9.4									60
65	13			11.3			9.5			7.8			7.5			65
70	12.9			11.2			9.5			8.1			7.8			70
75	12.7			11.1			9.5			8.2			7.9			75
80	12.5	10.6		11			9.5			8.2			7.9			80
85	12.3	10.4		10.9			9.4			8.1			7.9			85
90	12.1	10.1		10.8	9.4		9.3			8			7.8			90
95	11.9	9.9		10.6	9.2		9.2	8.4		7.9			7.7			95
100	11.7	9.7		10.5	9		9.1	8.3		7.8	7.4		7.7			100
105	11.4	9.4	7.6	10.3	8.8		9	8.1		7.8	7.3		7.6	7.3		105
110	11.2	9.2	7.4	10.2	8.7	7.1	8.9	8		7.7	7.3		7.6	7.3		110
115	11	9	7.3	10	8.5	7.1	8.8	7.9	6.7	7.7	7.3		7.5	7.2		115
120	10.8	8.8	7.2	9.9	8.4	7	8.7	7.7	6.7	7.6	7.2		7.5	7.1		120
125	10.6	8.6	7.1	9.7	8.2	6.9	8.6	7.6	6.7	7.6	7.1	6.4	7.5	7	6.4	125
130	10.4	8.5	7	9.6	8	6.8	8.5	7.5	6.6	7.6	7	6.4	7.4	6.9	6.3	130
135	10.2	8.3	7	9.4	7.9	6.8	8.4	7.4	6.5	7.5	6.9	6.3	7.4	6.9	6.3	135
140	10	8.1	6.9	9.3	7.8	6.7	8.3	7.3	6.5	7.4	6.8	6.3	7.2	6.8	6.2	140
145	9.8	8	6.8	9.1	7.6	6.7	8.2	7.2	6.4	7.2	6.8	6.2	7.1	6.7	6.2	145
150	9.5	7.8	6.7	9	7.5	6.6	8.1	7.1	6.4	7.1	6.7	6.2	7	6.6	6.2	150
155	9.3	7.7	6.7	8.8	7.4	6.5	8	7	6.4	6.9	6.6	6.1	6.9	6.5	6.1	155
160	9.1	7.5	6.6	8.6	7.3	6.5	7.8	6.9	6.3	6.8	6.4	6.1	6.7	6.4	6.1	160
165	8.9	7.4	6.6	8.5	7.2	6.5	7.6	6.8	6.3	6.7	6.3	6	6.6	6.3	6	165
170	8.7	7.3	6.5	8.3	7.1	6.4	7.4	6.7	6.2	6.5	6.2	6	6.4	6.1	5.9	170
175	8.5	7.2	6.5	8.1	7	6.4	7.3	6.7	6.2	6.3	6	5.9	6.3	6	5.9	175
180	8.3	7.1	6.5	8	6.9	6.4	7.1	6.6	6.2	6.1	5.9	5.8	6.1	5.9	5.8	180
185	8.1	7	6.4	7.8	6.8	6.3	6.9	6.5	6.2	6	5.7	5.7	5.9	5.7	5.7	185
190	8	6.9	6.4	7.7	6.7	6.3	6.8	6.4	6.2	5.8	5.6	5.6	5.7	5.6	5.5	190
195	7.8	6.8	6.4	7.5	6.7	6.3	6.6	6.3	6.1	5.6	5.5	5.5	5.5	5.5	5.4	195
200	7.7	6.7	6.4	7.4	6.6	6.3	6.5	6.2	6.1	5.4	5.4	5.4	5.3	5.4	5.3	200
205	7.5	6.7	6.4	7.2	6.5	6.3	6.3	6	6	5.2	5.3	5.3	5.2	5.3	5.2	205
210	7.4	6.6	6.4	7.1	6.5	6.3	6.2	5.9	5.9	5	5.1	5.2	5	5.1	5.2	210
215	7.2	6.6	6.4	6.9	6.5	6.3	6.1	5.8	5.8	4.8	5	5.1	4.8	5	5.1	215
220	7.1	6.5	6.4	6.8	6.4	6.3	5.9	5.7	5.7	4.6	4.8	5	4.6	4.8	4.9	220
225	6.9	6.5	6.4	6.6	6.4	6.3	5.8	5.6	5.6	4.5	4.7	4.8	4.5	4.7	4.8	225
230	6.8	6.5	6.4	6.5	6.3	6.3	5.6	5.5	5.6	4.3	4.5	4.7	4.3	4.5	4.7	230
235	6.7	6.4	6.4	6.3	6.2	6.3	5.4	5.4	5.5	4.1	4.3	4.6	4.1	4.3	4.6	235
240	6.4	6.4	6.4	6	6.1	6.3	5.3	5.3	5.4	3.9	4.2	4.4	3.8	4.1	4.4	240
245	6	6.3	6.4	5.8	6	6.2	5.1	5.2	5.3	3.8	4	4.3	3.6	4	4.3	245
250	5.6	6.1	6.4	5.5	5.8	6.1	4.9	5	5.2	3.6	3.9	4.1	3.3	3.8	4.1	250
255	5.4	5.8	6	5.1	5.6	5.8	4.7	4.9	5.1	3.5	3.7	3.9	3	3.6	3.9	255
260	5.2	5.4	5.5	4.6	5.4	5.5	4.5	4.8	4.9	3.3	3.6	3.8	2.8	3.3	3.7	260
265	5.1	5.2		4.4	5	5.2	4.2	4.6	4.8	3.1	3.4	3.6		3.1	3.3	265
270	4.9	5		4.2	4.4	4.6	3.9	4.5	4.6		3.2	3.4		2.8	3	270
275	3.7	4.8		4.1	4.2	4.4	3.4	4.2	4.4		3	3.2		2.5	2.7	275
280		3.6		4	4.1		2.8	3.8	4		2.8	3			2.3	280
285				3.8	3.9			3.3	3.4			2.6				285
290				2.3	3.8			2.4	2.5							290

t_240_002_50401_00_000 / 52401_00_000 / 54401_00_000

Lifting heights Hauteurs de levage

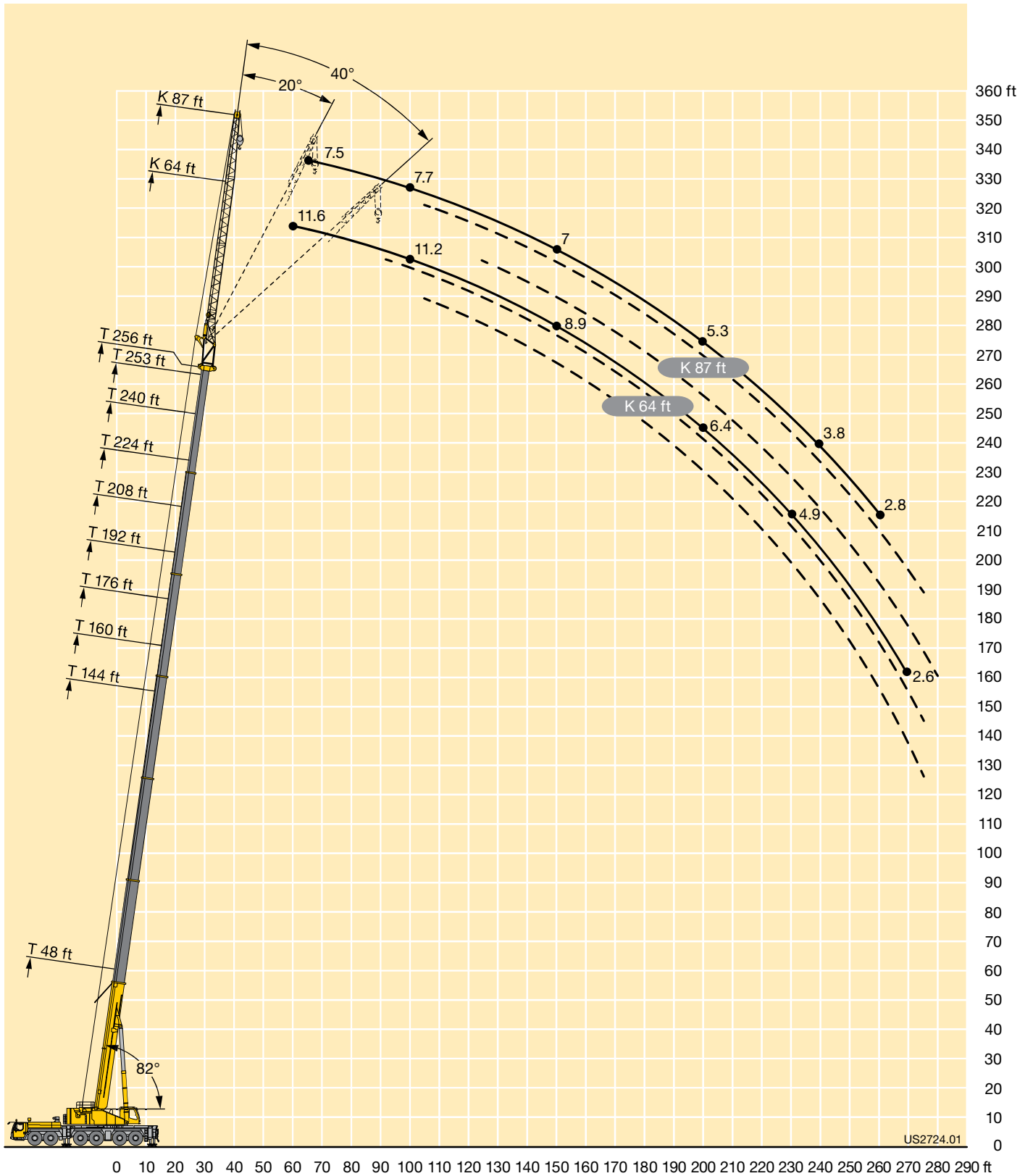

Lifting capacities Forces de levage

TK

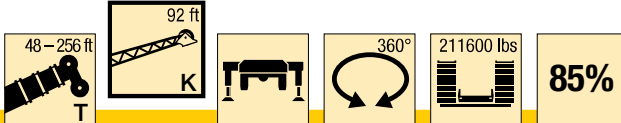

ft	48 ft			144 ft			160 ft			176 ft			192 ft			ft
	92 ft			92 ft			92 ft			92 ft			92 ft			
	0°	20°	40°	0°	20°	40°	0°	20°	40°	0°	20°	40°	0°	20°	40°	
15	15.9															15
16	15.9															16
17	15.9															17
18	15.9															18
19	15.9															19
20	16															20
22	15.9															22
24	15.9															24
26	15.8															26
28	15.6															28
30	15.4															30
32	15.2			15.4												32
34	15			15.8												34
36	14.8			15.9			14.9									36
38	14.5			16			15.1									38
40	14.3			15.9			15.2			14.1						40
45	13.7			15.9			15.2			14.2			12.9			45
50	13.1	11.6		15.7			15			14.2			13			50
55	12.5	10.9		15.4			14.8			14			13			55
60	11.9	10.3		15.1			14.6			13.8			12.9			60
65	11.2	9.7		14.8	12		14.3			13.6			12.7			65
70	10.6	9.2	7.8	14.4	11.6		14	11.5		13.3			12.5			70
75	10.1	8.8	7.5	14.1	11.2		13.7	11.1		13.1	10.9		12.3			75
80	9.5	8.3	7.2	13.7	10.8		13.4	10.7		12.8	10.5		12.1	10.2		80
85	9	8	7	13.4	10.5		13.1	10.4		12.6	10.2		11.9	9.9		85
90	8.5	7.6	6.8	13	10.1	7.8	12.8	10.1	7.8	12.3	9.9		11.6	9.7		90
95	8.1	7.3	6.7	12.6	9.8	7.6	12.5	9.8	7.6	12.1	9.7	7.5	11.4	9.4		95
100	7.7	7	6.5	12.3	9.5	7.5	12.2	9.5	7.4	11.8	9.4	7.4	11.2	9.2	7.2	100
105	7.3	6.8	6.4	11.9	9.2	7.3	11.9	9.3	7.3	11.5	9.1	7.2	11	8.9	7.1	105
110	7	6.6	6.3	11.5	9	7.2	11.5	9	7.2	11.3	8.9	7.1	10.8	8.7	7	110
115	6.7	6.5	6.3	11.2	8.7	7.1	11.2	8.8	7.1	11	8.7	7	10.6	8.5	6.9	115
120	6.5	6.4	6.3	10.8	8.5	7	10.9	8.5	6.9	10.7	8.5	6.9	10.4	8.3	6.8	120
125	6.2	6.3	6.3	10.5	8.2	6.9	10.6	8.3	6.8	10.4	8.3	6.8	10.1	8.1	6.7	125
130	6	6.3		10.1	8	6.8	10.3	8.1	6.7	10.2	8.1	6.7	9.9	8	6.6	130
135				9.8	7.8	6.7	9.9	7.9	6.7	9.9	7.9	6.6	9.7	7.8	6.6	135
140				9.4	7.6	6.6	9.7	7.7	6.6	9.7	7.7	6.6	9.4	7.6	6.5	140
145				9.1	7.4	6.5	9.3	7.5	6.5	9.4	7.5	6.5	9.2	7.5	6.4	145
150				8.8	7.3	6.5	9.1	7.4	6.4	9.1	7.4	6.4	9	7.3	6.4	150
155				8.5	7.2	6.4	8.8	7.2	6.4	8.9	7.3	6.4	8.8	7.2	6.3	155
160				8.3	7	6.4	8.6	7.1	6.3	8.6	7.1	6.3	8.6	7	6.3	160
165				8	6.9	6.3	8.3	7	6.3	8.4	7	6.2	8.4	6.9	6.2	165
170				7.8	6.8	6.3	8.1	6.9	6.3	8.2	6.9	6.2	8.2	6.8	6.1	170
175				7.6	6.7	6.3	7.8	6.7	6.2	8	6.8	6.2	7.9	6.7	6.1	175
180				7.4	6.6	6.3	7.6	6.7	6.2	7.8	6.7	6.1	7.8	6.6	6.1	180
185				7.2	6.5	6.3	7.5	6.6	6.2	7.6	6.6	6.1	7.6	6.6	6.1	185
190				7	6.4	6.3	7.3	6.5	6.2	7.4	6.5	6.1	7.4	6.5	6	190
195				6.8	6.4	6.3	7.1	6.4	6.2	7.2	6.4	6.1	7.3	6.4	6	195
200				6.7	6.3	6.3	7	6.4	6.2	7.1	6.4	6.1	7.1	6.4	6	200
205				6.5	6.3	6.3	6.8	6.3	6.2	7	6.3	6.1	7	6.3	6	205
210				6.4	6.3	5.4	6.7	6.3	6.2	6.8	6.3	6.1	6.9	6.2	6	210
215				6.2	6.3		6.6	6.2	6.2	6.7	6.2	6.1	6.8	6.2	6	215
220				6.1	6.3		6.4	6.2	6.2	6.6	6.2	6.1	6.7	6.1	6	220
225				5.7	6.3		6.3	6.2	5.1	6.5	6.2	6.1	6.6	6.1	6	225
230							6.2	6.2		6.4	6.2	6.1	6.5	6.1	6	230
235							6.1	6.2		6.3	6.2	6	6.4	6.1	6	235
240							4.1	6.2		6.2	6.2		6.3	6.1	6	240
245										6.1	6.2		6.2	6.1	6	245
250										5.4	6.2		6.1	6.1	5.7	250
255										2.6	4.9		6	6		255
260													5.9	6		260
265													4.1	6		265
270													3.8	3.9		270

t_240_002_50501_00_000 / 52501_00_000 / 54501_00_000

Lifting capacities Forces de levage

TK

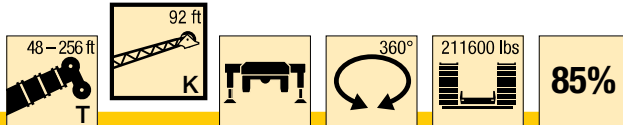

ft	208 ft			224 ft			240 ft			253 ft			256 ft			ft
	92 ft			92 ft			92 ft			92 ft			92 ft			
	0°	20°	40°	0°	20°	40°	0°	20°	40°	0°	20°	40°	0°	20°	40°	
50	11.5															50
55	11.5			9.9												55
60	11.5			10.1			8.2									60
65	11.5			10.2			8.5			6.9						65
70	11.4			10.1			8.7			7.2			6.9			70
75	11.2			10			8.7			7.4			7.1			75
80	11.1			9.9			8.6			7.5			7.3			80
85	10.9	9.4		9.8			8.5			7.5			7.3			85
90	10.7	9.2		9.7	8.5		8.4			7.5			7.3			90
95	10.6	9		9.6	8.4		8.4			7.4			7.3			95
100	10.4	8.8		9.4	8.2		8.3	7.5		7.4			7.3			100
105	10.3	8.6		9.3	8.1		8.2	7.4		7.3	6.9		7.2	6.8		105
110	10.1	8.4	6.9	9.2	7.9		8.1	7.3		7.3	6.8		7.1	6.8		110
115	9.9	8.2	6.8	9.1	7.7	6.6	8	7.2		7.2	6.8		7.1	6.7		115
120	9.7	8	6.7	8.9	7.6	6.5	7.9	7.1	6.2	7.2	6.7		7	6.6		120
125	9.6	7.9	6.6	8.8	7.5	6.4	7.8	7	6.2	7.1	6.6		7	6.5		125
130	9.4	7.7	6.5	8.7	7.3	6.3	7.7	6.9	6.1	7	6.5	5.9	6.9	6.4	5.8	130
135	9.2	7.6	6.4	8.6	7.2	6.3	7.7	6.8	6.1	7	6.4	5.9	6.9	6.4	5.8	135
140	9	7.4	6.4	8.4	7.1	6.2	7.6	6.7	6	6.9	6.4	5.8	6.8	6.3	5.8	140
145	8.8	7.3	6.3	8.3	7	6.2	7.5	6.6	6	6.8	6.3	5.8	6.7	6.2	5.8	145
150	8.7	7.1	6.3	8.1	6.9	6.1	7.4	6.5	5.9	6.7	6.2	5.7	6.6	6.2	5.7	150
155	8.5	7	6.2	8	6.8	6.1	7.3	6.5	5.9	6.6	6.2	5.7	6.5	6.1	5.7	155
160	8.3	6.9	6.1	7.9	6.7	6	7.2	6.4	5.9	6.5	6.1	5.7	6.4	6.1	5.7	160
165	8.1	6.8	6.1	7.7	6.6	6	7.1	6.3	5.8	6.4	6	5.7	6.4	6	5.6	165
170	7.9	6.7	6.1	7.6	6.5	5.9	7	6.3	5.8	6.3	5.9	5.6	6.2	5.9	5.6	170
175	7.8	6.7	6	7.4	6.4	5.9	6.9	6.2	5.8	6.2	5.8	5.6	6.1	5.8	5.6	175
180	7.6	6.6	6	7.3	6.4	5.9	6.8	6.1	5.7	6	5.7	5.6	6	5.7	5.6	180
185	7.4	6.5	6	7.2	6.3	5.9	6.7	6.1	5.7	5.8	5.6	5.5	5.8	5.6	5.5	185
190	7.3	6.4	5.9	7.1	6.2	5.8	6.6	6	5.7	5.7	5.5	5.4	5.6	5.5	5.4	190
195	7.1	6.3	5.9	7	6.2	5.8	6.5	6	5.7	5.5	5.4	5.3	5.5	5.4	5.3	195
200	7	6.3	5.9	6.8	6.1	5.8	6.3	5.9	5.7	5.3	5.3	5.3	5.3	5.3	5.2	200
205	6.9	6.2	5.9	6.7	6.1	5.8	6.2	5.8	5.7	5.1	5.2	5.2	5.1	5.1	5.2	205
210	6.8	6.2	5.9	6.6	6	5.8	6.1	5.7	5.7	5	5	5.1	4.9	5	5.1	210
215	6.7	6.1	5.9	6.5	6	5.8	5.9	5.6	5.6	4.8	4.9	5	4.8	4.9	5	215
220	6.6	6	5.9	6.5	5.9	5.8	5.8	5.5	5.6	4.6	4.8	4.9	4.6	4.7	4.9	220
225	6.5	6	5.9	6.4	5.9	5.8	5.7	5.5	5.5	4.5	4.6	4.8	4.4	4.6	4.8	225
230	6.4	6	5.9	6.3	5.9	5.8	5.5	5.4	5.4	4.3	4.5	4.7	4.3	4.5	4.7	230
235	6.4	6	5.9	6.2	5.8	5.8	5.4	5.3	5.4	4.1	4.3	4.6	4.1	4.3	4.5	235
240	6.3	5.9	5.9	6	5.8	5.8	5.2	5.2	5.3	4	4.2	4.5	3.9	4.1	4.4	240
245	6.1	5.9	5.9	5.8	5.7	5.8	5.1	5.1	5.2	3.8	4	4.3	3.7	4	4.3	245
250	5.8	5.9	5.9	5.6	5.7	5.8	4.9	5	5.1	3.7	3.9	4.1	3.4	3.8	4.1	250
255	5.4	5.8	5.9	5.3	5.6	5.8	4.7	4.9	5	3.5	3.7	4	3.2	3.6	4	255
260	5.3	5.6	5.8	4.9	5.5	5.7	4.5	4.7	4.9	3.3	3.6	3.8	2.9	3.4	3.8	260
265	5.1	5.2	5.3	4.4	5.2	5.4	4.3	4.6	4.8	3.2	3.4	3.6	2.6	3.2	3.5	265
270	4.9	5.1		4.2	4.8	5	4.1	4.5	4.6	3	3.3	3.5	2.4	3	3.2	270
275	4.7	4.9		4.1	4.2	4.4	3.7	4.3	4.4	2.7	3.1	3.3		2.7	2.9	275
280	3.6	4.7		3.9	4.1	4.2	3.2	4.1	4.2		2.9	3.1		2.4	2.5	280
285		3.5		3.8	4		2.8	3.7	3.8		2.8	3			2.2	285
290				3.6	3.8		2.1	3.1	3.3			2.7				290
295					3.6			2.6	2.7							295

t_240_002_50501_00_000 / 52501_00_000 / 54501_00_000

Lifting capacities Forces de levage

TK

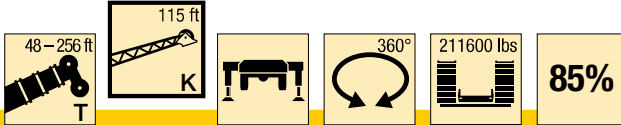

ft	48 ft			144 ft			160 ft			176 ft			192 ft			ft
	115 ft			115 ft			115 ft			115 ft			115 ft			
	0°	20°	40°	0°	20°	40°	0°	20°	40°	0°	20°	40°	0°	20°	40°	
19	9.1															19
20	9.1															20
22	9.2															22
24	10.1															24
26	10.8															26
28	11.2															28
30	11.1															30
32	10.9															32
34	10.8															34
36	10.6			9.3												36
38	10.5			9.7												38
40	10.3			10			9.1									40
45	9.9			10.7			9.8			8.7						45
50	9.5			11			10.3			9.2			7.8			50
55	9			10.9			10.4			9.6			8.3			55
60	8.6	7.4		10.7			10.2			9.7			8.7			60
65	8.2	7		10.4			10			9.5			8.8			65
70	7.7	6.6		10.2			9.8			9.4			8.7			70
75	7.2	6.3		9.9			9.6			9.2			8.6			75
80	6.8	6		9.7	7.3		9.4	7.2		9			8.4			80
85	6.5	5.7		9.4	7.1		9.2	7		8.8	6.9		8.2			85
90	6.1	5.5	4.8	9.1	6.9		8.9	6.8		8.6	6.7		8.1	6.4		90
95	5.8	5.2	4.6	8.8	6.6		8.7	6.6		8.4	6.5		7.9	6.3		95
100	5.6	5	4.5	8.6	6.4		8.4	6.4		8.2	6.3		7.7	6.2		100
105	5.3	4.8	4.3	8.3	6.2	4.6	8.2	6.2		7.9	6.1		7.5	6		105
110	5.1	4.6	4.2	8	6.1	4.5	7.9	6	4.5	7.7	6		7.4	5.8		110
115	4.9	4.4	4.1	7.7	5.9	4.5	7.7	5.9	4.5	7.5	5.8	4.4	7.2	5.7		115
120	4.7	4.3	3.9	7.4	5.7	4.4	7.4	5.7	4.4	7.3	5.7	4.3	7	5.6	4.3	120
125	4.5	4.1	3.9	7.1	5.6	4.4	7.2	5.6	4.3	7.1	5.5	4.3	6.8	5.4	4.2	125
130	4.3	4	3.8	6.9	5.4	4.3	6.9	5.4	4.3	6.9	5.4	4.2	6.7	5.3	4.2	130
135	4.2	3.9	3.8	6.6	5.3	4.2	6.7	5.3	4.2	6.7	5.3	4.2	6.5	5.2	4.1	135
140	4	3.8	3.8	6.4	5.1	4.2	6.5	5.2	4.2	6.5	5.1	4.2	6.3	5.1	4.1	140
145	3.9	3.8	3.8	6.2	5	4.2	6.3	5	4.2	6.3	5	4.1	6.2	5	4	145
150	3.8	3.8		6	4.9	4.1	6.1	4.9	4.1	6.1	4.9	4.1	6	4.8	4	150
155	3.7	3.8		5.8	4.8	4.1	5.9	4.8	4	6	4.8	4	5.9	4.7	4	155
160				5.7	4.6	4	5.8	4.7	4	5.8	4.7	4	5.7	4.6	3.9	160
165				5.5	4.6	3.9	5.6	4.6	3.9	5.7	4.6	3.9	5.6	4.6	3.9	165
170				5.3	4.5	3.9	5.5	4.5	3.9	5.5	4.5	3.9	5.5	4.5	3.8	170
175				5.2	4.4	3.9	5.3	4.4	3.8	5.3	4.4	3.8	5.3	4.4	3.8	175
180				5	4.3	3.8	5.2	4.3	3.8	5.2	4.3	3.8	5.2	4.3	3.7	180
185				4.9	4.2	3.8	5	4.2	3.8	5.1	4.3	3.7	5.1	4.2	3.7	185
190				4.8	4.1	3.8	4.9	4.2	3.8	5	4.2	3.7	4.9	4.2	3.7	190
195				4.7	4	3.8	4.8	4.1	3.7	4.9	4.1	3.7	4.8	4.1	3.6	195
200				4.5	4	3.8	4.7	4	3.7	4.7	4	3.7	4.7	4	3.6	200
205				4.4	3.9	3.8	4.6	4	3.7	4.6	4	3.6	4.6	4	3.6	205
210				4.3	3.9	3.8	4.4	3.9	3.7	4.5	3.9	3.6	4.5	3.9	3.6	210
215				4.2	3.8	3.8	4.3	3.9	3.7	4.4	3.9	3.6	4.4	3.8	3.6	215
220				4.1	3.8	3.8	4.2	3.8	3.7	4.3	3.8	3.6	4.3	3.8	3.6	220
225				4	3.8	3.8	4.2	3.8	3.7	4.3	3.8	3.6	4.2	3.8	3.6	225
230				4	3.8	3.8	4.1	3.7	3.7	4.2	3.7	3.6	4.2	3.7	3.6	230
235				3.9	3.8		4	3.7	3.7	4.1	3.7	3.6	4.1	3.7	3.6	235
240				3.8	3.8		3.9	3.7	3.7	4	3.7	3.6	4	3.6	3.6	240
245				3.8	3.8		3.9	3.7		3.9	3.7	3.6	4	3.6	3.6	245
250							3.8	3.7		3.9	3.6	3.6	3.9	3.6	3.6	250
255							3.7	3.7		3.8	3.6	3.6	3.8	3.6	3.6	255
260							3.7	3.7		3.7	3.6		3.8	3.6	3.6	260
265										3.7	3.6		3.7	3.6	3.6	265
270										3.7	3.6		3.7	3.6	3.6	270
275										2.5	3.6		3.6	3.6		275
280													3.6	3.6		280
285													3.3	3.6		285
290													2.4	3.4		290
295														2.5		295

t_240_002_50601_00_000 / 52601_00_000 / 54601_00_000

Lifting capacities Forces de levage

TK

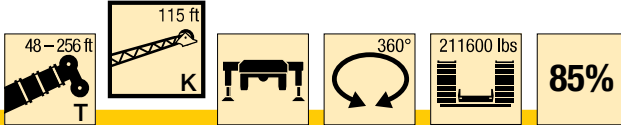

ft	208 ft			224 ft			240 ft			253 ft			256 ft		ft
	115 ft			115 ft			115 ft			115 ft			115 ft		
	0°	20°	40°	0°	20°	40°	0°	20°	40°	0°	20°	40°	0°	20°	
55	6.7														55
60	7.1			5.6											60
65	7.5			5.9			4.6								65
70	7.6			6.3			4.8								70
75	7.7			6.5			5.1			4			3.8		75
80	7.6			6.6			5.3			4			3.8		80
85	7.5			6.6			5.4			4.1			3.8		85
90	7.3			6.6			5.5			4.2			3.8		90
95	7.2			6.6			5.6			4.3			3.8		95
100	7.1	5.9		6.5			5.6			4.3			3.9		100
105	7	5.8		6.4	5.4		5.6			4.3			3.9		105
110	6.8	5.6		6.3	5.3		5.6			4.3			3.9		110
115	6.7	5.5		6.2	5.2		5.5	4.7		4.3			3.9		115
120	6.6	5.4		6.1	5.1		5.5	4.7		4.4	4.2		3.9	4.1	120
125	6.5	5.3	4.1	6	5		5.4	4.7		4.4	4.2		3.9	4.1	125
130	6.3	5.1	4	5.9	4.9		5.3	4.6		4.4	4.2		3.9	4.1	130
135	6.2	5	4	5.8	4.8	3.8	5.3	4.5		4.4	4.2		3.9	4.1	135
140	6.1	4.9	4	5.6	4.7	3.8	5.2	4.4	3.6	4.4	4.1		3.9	4	140
145	5.9	4.8	3.9	5.5	4.6	3.8	5.1	4.4	3.6	4.3	4.1		3.9	4	145
150	5.8	4.7	3.9	5.4	4.5	3.8	5	4.3	3.6	4.3	4	3.4	3.9	4	150
155	5.7	4.6	3.9	5.3	4.4	3.7	4.9	4.2	3.6	4.2	4	3.4	3.9	4	155
160	5.5	4.5	3.8	5.2	4.4	3.7	4.8	4.1	3.5	4.2	3.9	3.4	3.9	3.9	160
165	5.4	4.4	3.8	5.1	4.3	3.7	4.8	4.1	3.5	4.2	3.9	3.3	3.9	3.9	165
170	5.3	4.4	3.8	5	4.2	3.6	4.7	4	3.5	4.1	3.8	3.3	3.8	3.8	170
175	5.2	4.3	3.7	4.9	4.2	3.6	4.6	4	3.5	4.1	3.8	3.3	3.8	3.8	175
180	5	4.2	3.7	4.8	4.1	3.6	4.5	3.9	3.5	4	3.7	3.3	3.7	3.7	180
185	4.9	4.1	3.6	4.7	4	3.6	4.5	3.8	3.4	4	3.7	3.3	3.7	3.7	185
190	4.8	4.1	3.6	4.7	3.9	3.5	4.4	3.8	3.4	3.9	3.6	3.3	3.7	3.6	190
195	4.7	4	3.6	4.6	3.9	3.5	4.3	3.7	3.4	3.9	3.6	3.3	3.6	3.6	195
200	4.6	4	3.5	4.5	3.9	3.5	4.2	3.7	3.4	3.8	3.5	3.3	3.6	3.5	200
205	4.5	3.9	3.5	4.4	3.8	3.5	4.2	3.6	3.4	3.7	3.5	3.3	3.6	3.5	205
210	4.4	3.8	3.5	4.3	3.8	3.4	4.1	3.6	3.4	3.7	3.5	3.3	3.5	3.4	210
215	4.4	3.8	3.5	4.3	3.7	3.4	4	3.6	3.3	3.6	3.4	3.2	3.5	3.4	215
220	4.3	3.7	3.5	4.2	3.7	3.4	4	3.5	3.3	3.5	3.4	3.2	3.5	3.4	220
225	4.2	3.7	3.5	4.1	3.6	3.4	3.9	3.5	3.3	3.4	3.3	3.2	3.3	3.4	225
230	4.1	3.7	3.5	4	3.6	3.4	3.9	3.5	3.3	3.2	3.3	3.2	3.2	3.3	230
235	4.1	3.6	3.5	4	3.5	3.4	3.8	3.4	3.3	3.1	3.2	3.2	3.1	3.2	235
240	4	3.6	3.5	3.9	3.5	3.4	3.8	3.4	3.3	2.9	3.1	3.2	2.9	3.1	240
245	3.9	3.6	3.5	3.9	3.5	3.4	3.7	3.4	3.3	2.8	3	3.2	2.8	3	245
250	3.9	3.5	3.5	3.8	3.4	3.4	3.6	3.4	3.3	2.6	2.9	3.1	2.6	2.9	250
255	3.8	3.5	3.5	3.7	3.4	3.4	3.5	3.3	3.3	2.5	2.8	3.1	2.5	2.8	255
260	3.8	3.5	3.5	3.7	3.4	3.4	3.5	3.3	3.3	2.3	2.7	3	2.3	2.6	260
265	3.7	3.5	3.5	3.6	3.4	3.4	3.4	3.3	3.3	2.2	2.5	2.8		2.5	265
270	3.7	3.5	3.5	3.5	3.4	3.4	3.3	3.3	3.3		2.4	2.7		2.4	270
275	3.6	3.5	3.5	3.4	3.4	3.4	3.2	3.2	3.3		2.2	2.5		2.2	275
280	3.5	3.5	3.5	3.2	3.3	3.4	3	3.1	3.3			2.4			280
285	3.5	3.5		2.9	3.3	3.4		3.1	3.3			2.2			285
290	3.5	3.5		2.8	3.2	3.4		3	3.3						290
295	3.3	3.5		2.6	2.8	3.2		2.8	3.1						295
300	2.2	3.4		2.5	2.7				2.7						300
305		2.6			2.6										305
310					2.4										310

t_240_002_50601_00_000 / 52601_00_000 / 54601_00_000

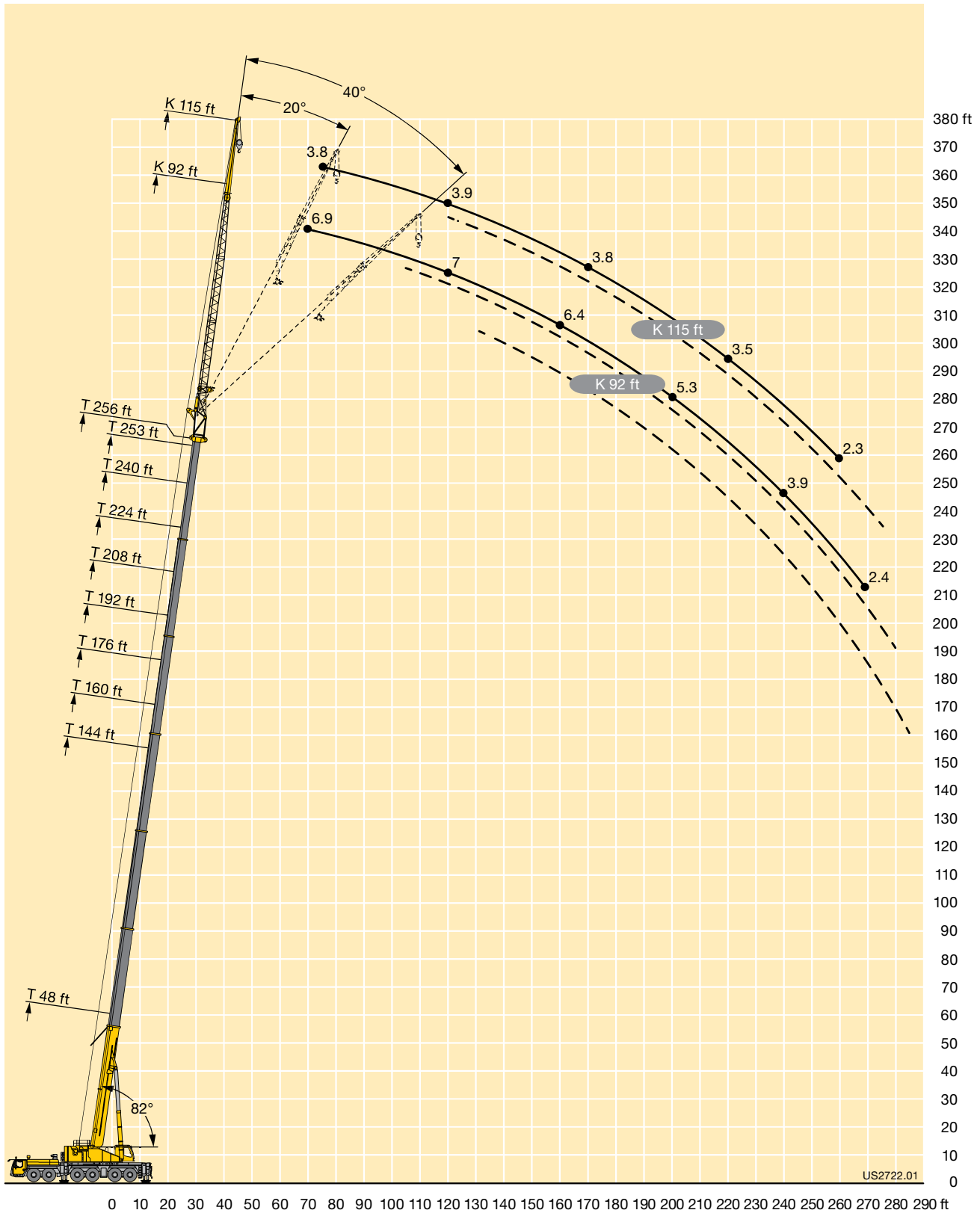

Lifting capacities Forces de levage

TNZK

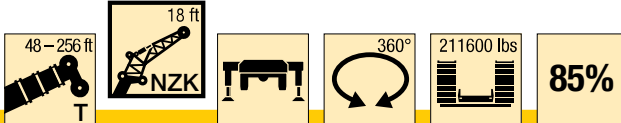

ft	48 ft			64 ft			80 ft			96 ft			112 ft			128 ft			144 ft			160 ft			ft
	18 ft			18 ft			18 ft			18 ft			18 ft			18 ft			18 ft						
	0°	20°	40°	0°	20°	40°	0°	20°	40°	0°	20°	40°	0°	20°	40°	0°	20°	40°	0°	20°	40°	0°	20°	40°	
12	128.3	101.2																						12	
13	125.9	99.2	84.3	130.9	103																			13	
14	122.7	97.2	82.9	130.3	101.1		130.4																	14	
15	119.5	95.3	81.7	127.6	99.4	83.9	129.2	100.7																15	
16	116.3	93.5	80.5	124.9	97.8	82.8	127.4	99.6	126.8															16	
17	113.7	91.8	79.3	122.4	96.2	81.8	125.2	98.2	125.1															17	
18	111.2	90.1	78.2	120	94.7	80.8	123.1	96.8	81.8	123.4	97.5	121.2												18	
19	108.6	88.4	77.1	117.6	93.3	79.9	121	95.5	81	121.7	96.4	119.9												19	
20	106	86.9	76.1	115.2	91.9	78.9	119	94.2	80.2	120	95.3	118.6												20	
22	101.2	84	74	110.7	89.2	77.1	115.1	91.7	78.5	116.6	93	79.4	115.9	93.5	105.6									22	
24	96.9	81.1	72.2	106.7	86.4	75.3	111.2	89.2	77	113.1	90.8	77.9	113.1	91.5	78.3	105.6	91.1							24	
26	92.9	78.6	70.4	102.6	84.1	73.6	107.5	87	75.4	109.9	88.7	76.5	110.2	89.5	77	105.3	89.6	95.2						26	
28	89.1	76.1	68.8	98.8	81.8	72.2	104.2	84.8	74.1	106.9	86.7	75.2	107.5	87.6	75.8	104.7	88.2	76.8	94.7	83.6				28	
30	86	73.8	67.3	95.4	79.5	70.8	101.1	82.8	72.7	103.9	84.8	73.9	104.8	85.8	74.6	103.9	86.9	75.8	94.2	82.7	79.4			30	
32	82.8	71.9	65.9	92.3	77.5	69.4	98	81	71.4	100.9	83	72.8	102.4	84.2	73.5	102.4	85.6	74.8	93.4	81.7	73	79.4		32	
34	79.9	70.1	64.7	89.2	75.6	68.2	95.1	79.2	70.2	98.5	81.2	71.6	100.1	82.6	72.4	100.8	84.3	73.9	92.4	80.7	72.2	79.3	73.9	34	
36	77.4	68.3	63.6	86.5	73.8	67	92.4	77.5	69.1	96.1	79.6	70.5	97.8	81.1	71.4	99.1	83.1	73	91.5	79.8	71.4	79	73.3	67.7	36
38	74.9	66.7	62.6	84.1	72.1	65.9	89.9	75.9	68	93.7	78.2	69.5	95.6	79.7	70.5	97.4	81.8	72.2	90.4	78.8	70.7	78.6	72.7	67.2	38
40	72.6	65.2	61.7	81.7	70.7	64.9	87.6	74.3	67	91.4	76.8	68.5	93.6	78.2	69.5	95.7	80.6	71.3	89.3	77.9	69.9	78.2	72	66.6	40
45	67.9	62.2	60.1	76.3	67.2	62.7	82.3	70.8	64.8	86.3	73.3	66.3	88.9	75.2	67.4	91.6	77.6	69.4	86.3	75.4	68.2	76.5	70.2	65.2	45
50	64.1	59.9	59.4	71.7	64.3	60.9	77.7	67.9	62.9	81.8	70.4	64.3	84.4	72.3	65.5	88	75	67.5	83.1	73.2	66.6	73.6	67.9	63.7	50
55	60.5	58.2	9.1	68	61.9	59.7	73.7	65.2	61.2	78	67.8	62.6	80.7	69.7	63.7	84.3	72.5	66	78.7	71	65.1	69.8	65.1	61.7	55
60				64.7	59.9	32.6	70.2	63	59.9	74.4	65.6	61.2	77.2	67.3	62.2	81.2	70.2	64.4	73.8	69	63.8	66.1	62.3	59.3	60
65				62.2	58.8	16	67.2	61.1	58.9	71.2	63.4	59.9	74.2	65.3	60.9	78.2	68.3	63.1	69.1	66.9	62.6	62.5	59.9	57.1	65
70				59.3	57.5	9.5	64.5	59.6	47.6	68.4	61.7	59	71.4	63.5	59.8	74.8	66.5	61.9	64.9	64.3	61	59	57.5	55.1	70
75				41.9			62.3	58.4	22.2	65.9	60.1	58.1	68.9	61.7	58.8	68.5	64.9	60.9	60.9	60.6	58.8	55.6	55.1	53.1	75
80							60.5	57.8	13.8	63.9	58.9	57.8	64.2	60.4	58	62.6	63	60.1	57.1	56.9	56.4	52.7	52.5	51.1	80
85							58.2	55.9	9.2	60.2	57.8	29	59	59	57.4	57.3	57.9	58	53.7	53.6	53.6	49.8	49.8	49	85
90							40.8	13.5		55.6	55.9	18.1	54.4	54.8	55	52.7	53.3	53.5	51.4	50.4	50.5	47.2	47.2	46.9	90
95										51.5	51.8	12.5	50.2	50.6	37.1	48.6	49.1	49.3	49.3	47.1	47.4	44.9	44.8	44.8	95
100										47.9	44.9	9	46.6	46.9	22.6	44.9	45.3	45.5	46.2	45.1	44.3	42.6	42.6	42.6	100
105										35.8	15.6	5.7	43.3	43.5	15.8	43.1	41.9	40.7	42.9	43.1	42.9	40.3	40.4	40.5	105
110													40.3	40.5	11.7	41.4	40.2	27.7	39.9	40.2	40.4	38.2	38.2	38.3	110
115													37.6	37.7	8.9	38.9	39	19.2	37.1	37.4	37.6	35.5	35.9	36.1	115
120													31	17	6.3	36.4	36.6	14.4	34.6	34.9	32.4	33	33.3	33.5	120
125																34.1	34.3	11.2	32.3	32.5	22.8	31.3	31.4	31.5	125
130																32	32.1	8.8	30.2	30.4	17.2	29.5	29.8	29.9	130
135																25	18.2	6.6	28.2	28.3	13.5	27.5	27.7	26.7	135
140																			26.3	26.4	10.8	25.6	25.8	20.1	140
145																			24.6	24.7	8.7	23.8	24	15.8	145
150																			20.7	19	6.9	22.2	22.4	12.7	150
155																						20.7	20.9	10.5	155
160																						19.4	19.4	8.6	160
165																						16.4	16.4	7	165
170																						10.5	9.4		170

t_240_002_56001_00_000

Lifting capacities Forces de levage

TNZK

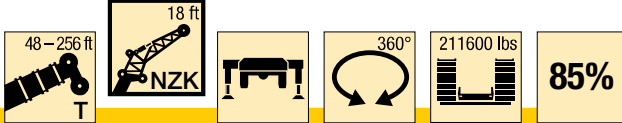

ft	176 ft			192 ft			208 ft			224 ft			240 ft			253 ft			256 ft			ft		
	18 ft			18 ft			18 ft			18 ft			18 ft			18 ft			18 ft					
	0°	20°	40°	0°	20°	40°	0°	20°	40°	0°	20°	40°	0°	20°	40°	0°	20°	40°	0°	20°	40°			
34	64.7																					34		
36	64.5																						36	
38	64.2	64.7		51.5																			38	
40	64	64.5		51.3																			40	
45	63.2	63.7	61	50.8	51.2	51.4	41.6																45	
50	62.2	62.8	60	50.3	50.7	51.2	41.2	41.5	42.2	34			25.4										50	
55	60.7	60.6	58.7	49.7	50	50.5	40.9	41.2	41.3	33.8	33.8	34.1	25.3	25.4		21				20.4			55	
60	57.9	57.8	56.7	48.7	48.8	49	40.3	40.1	40.2	33.2	33.2	33.5	25.1	25.2	25.1	21	21			20.4	20.4		60	
65	55	54.9	54.4	46.9	47	47.2	39.1	38.9	39	32.5	32.4	32.6	24.9	24.9	25	20.9	20.9	20.9		20.3	20.4	20.3	65	
70	52.2	52.2	52.1	44.9	45	45.3	37.9	37.7	37.7	31.6	31.4	31.5	24.6	24.5	24.6	20.7	20.7	20.8		20.2	20.3	20.3	70	
75	49.6	49.5	49.7	43	43.1	43.3	36.6	36.4	36.3	30.6	30.3	30.4	24.1	24	24.1	20.4	20.3	20.4		20	20	20.1	75	
80	46.9	4	47.1	41.1	41.1	41.4	35.3	35	34.9	29.5	29.3	29.3	23.5	23.4	23.5	19.9	19.9	19.9		19.6	19.6	19.6	80	
85	44.4	44.4	44.6	39.2	39.2	39.5	34	33.7	33.6	28.5	28.3	28.3	22.8	22.8	22.8	19.4	19.3	19.4		19.1	19.1	19.1	85	
90	42.1	42.1	42.3	37.3	37.4	37.6	32.7	32.4	32.3	27.5	27.3	27.3	22.2	22.1	22.2	18.8	18.7	18.8		18.6	18.5	18.5	90	
95	39.8	40	40.1	35.5	35.6	35.8	31.4	31.2	31.1	26.6	26.3	26.3	21.5	21.4	21.5	18.2	18.1	18.2		18	17.9	18	95	
100	37.7	37.8	38	33.8	33.9	34.1	30.1	30	29.9	25.6	25.4	25.4	20.9	20.7	20.8	17.6	17.5	17.6		17.4	17.4	17.4	100	
105	35.9	35.9	36	32.1	32.2	32.5	28.9	28.8	28.8	24.7	24.5	24.5	20.2	20.1	20.1	17	16.9	17		16.8	16.8	16.8	105	
110	34	34.2	34.3	30.6	30.6	30.9	27.6	27.6	27.6	23.7	23.6	23.6	19.5	19.4	19.5	16.5	16.4	16.4		16.3	16.2	16.3	110	
115	32.2	32.4	32.5	29.1	29.2	29.4	26.3	26.4	26.5	22.9	22.7	22.7	18.9	18.8	18.8	15.9	15.8	15.9		15.8	15.7	15.7	115	
120	30.6	30.7	30.8	27.7	27.8	28	25.1	25.2	25.3	22.1	21.9	21.9	18.2	18.1	18.2	15.4	15.3	15.4		15.3	15.2	15.2	120	
125	29.1	29.2	29.3	26.3	26.5	26.6	24	24	24.2	21.3	21.2	21.2	17.6	17.5	17.6	14.8	14.8	14.8		14.7	14.7	14.7	125	
130	27.7	27.7	27.9	25	25.2	25.3	22.9	23	23.1	20.5	20.4	20.4	17.1	17	17	14.3	14.3	14.3		14.3	14.2	14.2	130	
135	25.8	26.1	26.3	23.8	23.9	24	21.8	22	22.1	19.7	19.6	19.7	16.5	16.4	16.5	13.8	13.8	13.8		13.8	13.7	13.8	135	
140	23.9	24.2	24.4	22.7	22.8	22.9	20.8	20.9	21	19	18.9	19	15.9	15.9	15.9	13.4	13.4	13.4		13.3	13.3	13.3	140	
145	22.9	22.9	23	21.5	21.7	21.8	19.8	19.9	20	18.2	18.2	18.3	15.4	15.4	15.4	12.9	12.9	12.9		12.9	12.8	12.9	145	
150	21.9	21.9	22	20.5	20.6	20.7	18.9	19	19.1	17.5	17.5	17.6	15	14.9	14.9	12.5	12.5	12.5		12.4	12.4	12.4	150	
155	20.6	20.8	18.2	19.2	19.5	19.6	17.9	18.1	18.2	16.7	16.8	16.9	14.5	14.4	14.5	12.1	12.1	12.1		12	12	12	155	
160	19.2	19.3	14.7	17.8	18.1	18.1	17.1	17.2	17.3	16	16.1	16.2	14	14	14	11.7	11.7	11.7		11.7	11.6	11.7	160	
165	17.8	18	12.2	17	17.1	17.1	16.2	16.3	16.4	15.3	15.4	15.4	13.6	13.5	13.6	11.3	11.3	11.3		11.3	11.3	11.3	165	
170	16.6	16.7	10.2	16.3	16.3	16.4	15.4	15.6	15.6	14.6	14.6	14.7	13.1	13.1	13.1	10.9	10.9	11		10.9	10.9	10.9	170	
175	15.5	15.6	8.6	15.7	15.7	13.9	14.5	14.7	14.7	13.8	13.9	14	12.7	12.7	12.7	10.6	10.6	10.6		10.6	10.6	10.6	175	
180	13.1	13.2	7.1	14.8	14.9	11.8	13.5	13.5	13.6	13.2	13.3	13.3	12.3	12.3	12.3	10.2	10.2	10.2		10.2	10.2	10.2	180	
185		9.3	9.1	13.8	13.9	10	12.9	12.9	13	12.6	12.7	12.7	11.9	11.9	11.9	9.8	9.8	9.9		9.7	9.8	9.8	185	
190				12.8	12.9	8.6	12.4	12.5	12.5	11.4	11.4	11.5	11.5	11.5	11.6	9.5	9.5	9.5		9.2	9.3	9.3	190	
195				10.7	10.7	7.2	11.9	12	11.4	10.9	11	11	11	11	11.1	9.1	9.1	9.2		8.8	8.8	8.9	195	
200				7.7	7.7	5.1	11.4	11.4	9.9	9.4	9.7	9.8	10.5	10.6	10.6	8.8	8.8	8.9		8.3	8.4	8.4	200	
205							9.8	9.9	8.5	7.5	7.9	7.8	10	10.1	10.1	8.5	8.5	8.5		7.9	7.9	8	205	
210							8.8	8.8	7.3	5.7	6	6	9.5	9.6	9.6	8.1	8.2	8.2		7.5	7.5	7.5	210	
215							5.7	5.8	4.2	4	4.3	4.2	8.8	8.9	8.9	7.8	7.9	7.9		7.1	7.1	7.1	215	
220										2.4	2.6	2.3	8.1	8.2	8.2	7.5	7.6	7.6		6.7	6.7	6.7	220	
225													7.4	7.5	7.5	7.2	7.2	7.3		6.3	6.3	6.3	225	
230													6.9	6.9	6.9	6.9	7	7		5.9	5.9	6	230	
235													6.4	6.4	6.4	6.5	6.5	6.5		5.6	5.6	5.6	235	
240													4.6	4.8	4.3	5.9	6	6		5.2	5.2	5.2	240	
245																5.3	5.3	5.3		4.9	4.8	4.8	245	
250																4.4	4.6	4.3		4.4	4.4	4.4	250	
255																	2.1				2.8	3	2.6	255

t_240_002_56001_00_000

Lifting capacities Forces de levage

TNZK

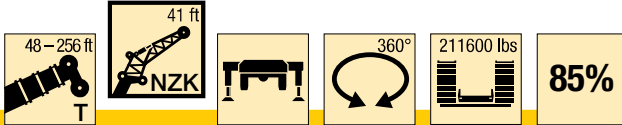

ft	48 ft			144 ft			160 ft			176 ft			192 ft			ft
	41 ft			41 ft			41 ft			41 ft			41 ft			
	0°	20°	40°	0°	20°	40°	0°	20°	40°	0°	20°	40°	0°	20°	40°	
12	52.4															12
13	52.1															13
14	51.7															14
15	51.2															15
16	50.7															16
17	50.1															17
18	49.5															18
19	48.9	39.2														19
20	48.3	39														20
22	47.1	37.2														22
24	45.8	35.3		52.7												24
26	44.3	33.6		52.8												26
28	42.9	32.1	23.1	52.8			47.4									28
30	41.4	30.8	22.8	52.6			47.4									30
32	40.1	29.5	22.1	52.4			47.4			41.7						32
34	38.8	28.5	21.6	52			47.3			41.6						34
36	37.5	27.4	21.1	51.6			47.1			41.6			35.6			36
38	36.3	26.4	20.6	51.2	38.4		46.7			41.5			35.7			38
40	34.9	25.6	20.2	50.7	37.5		46.3			41.3			35.7			40
45	31.2	23.6	19.2	49.3	35.2	23.1	45.4	36.1		40.7			35.5			45
50	28	22.1	18.4	47.8	33.3	22.3	44.5	34.1	22.5	40.1	34.5		35.2			50
55	25.4	20.8	17.8	46.3	31.6	21.7	43.5	32.3	21.9	39.5	32.9	22	34.8	31.8		55
60	23.4	19.6	17.4	44.6	30	21.1	42.6	30.8	21.3	38.8	31.3	21.4	34.4	31	21.5	60
65	21.6	18.7	17.1	42.8	28.7	20.6	41.4	29.5	20.8	38.2	29.9	20.9	34	30.1	20.9	65
70	20.1	18	17.1	41.1	27.5	20.1	40.1	28.3	20.3	37.5	28.7	20.5	33.6	28.8	20.5	70
75	18.8	17.6	16.3	39.5	26.4	19.6	38.8	27.2	19.9	36.7	27.5	20	33.1	27.7	20.1	75
80	17.8	17.5		38	25.4	19.2	37.6	26.2	19.5	35.8	26.6	19.7	32.7	26.7	19.7	80
85				36.5	24.5	18.9	36.4	25.2	19.1	34.9	25.7	19.3	32	25.8	19.4	85
90				34.8	23.6	18.6	35.2	24.4	18.8	34	24.8	19	31.4	25	19.1	90
95				33	22.9	18.3	34.1	23.6	18.5	33.1	24	18.7	30.7	24.3	18.8	95
100				31.3	22.2	18	32.9	22.9	18.2	32.3	23.3	18.4	29.9	23.5	18.5	100
105				29.6	21.5	17.8	31.4	22.3	18	31.5	22.7	18.1	29	22.9	18.2	105
110				28.2	20.9	17.6	30	21.6	17.8	30.5	22.1	17.9	27.8	22.3	18	110
115				26.9	20.4	17.4	28.6	21	17.6	29.4	21.5	17.7	26.5	21.7	17.8	115
120				25.7	19.9	17.3	27.3	20.6	17.4	28.2	21	17.5	25.4	21.1	17.6	120
125				24.6	19.4	17.2	26.3	20.1	17.3	27	20.5	17.4	24.3	20.7	17.4	125
130				23.7	19	17.1	25.2	19.6	17.1	25.9	20.1	17.2	23.2	20.3	17.3	130
135				22.8	18.6	17.1	24.2	19.2	17.1	24.7	19.7	17.2	22.2	19.9	17.2	135
140				21.9	18.3	17.1	23.3	18.9	17	23.6	19.3	17.1	21.2	19.5	17.1	140
145				21.1	18	15.7	22.6	18.6	17	22.6	18.9	17	20.2	19.1	17.1	145
150				20.4	17.8	10.1	21.8	18.2	17	21.5	18.6	17	19.3	18.7	17	150
155				19.7	17.6	7.2	21	18	16.5	20.4	18.4	17	18.4	18.3	17	155
160				19.1	17.5	5.4	20.4	17.8	12.4	19	18.1	17	17.5	17.8	16.8	160
165				18.6	17.5		19.4	17.6	8.7	17.7	17.8	17	16.7	17.1	16.6	165
170				17.2	16		18.1	17.5	6.6	17	17.1	15.1	16	16.4	16.4	170
175				10.2	6.9		17	17.4	5.1	16.3	16.5	10.5	15	15.6	15.8	175
180							15.9	16.3		15.5	15.8	7.8	14	14.7	15	180
185							13.3	15.2		14.5	15	6.1	13.1	13.6	12.2	185
190							7.7	7.5		13.6	14	4.9	12.6	12.7	9.1	190
195										12.7	13		12.1	12.2	7.2	195
200										10.4	12.1		11.6	11.7	5.8	200
205										6.1	7.8		11	11.3		205
210													10.3	10.6		210
215													8.3	9.8		215
220													7.1	7.2		220

t_240_002_56101_00_000

Lifting capacities Forces de levage

TNZK

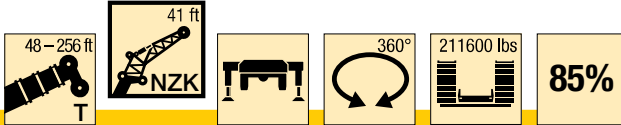

ft	208 ft			224 ft			240 ft			253 ft			256 ft			ft
	41 ft			41 ft			41 ft			41 ft			41 ft			
	0°	20°	40°	0°	20°	40°	0°	20°	40°	0°	20°	40°	0°	20°	40°	
45	30			23.3												45
50	30.1			23.5			19.4									50
55	29.9			23.6			19.4			16.4			15.9			55
60	29.7	28.3		23.8			19.4			16.4			15.9			60
65	29.5	27.8	20.9	23.9	23.9		19.3			16.4			16			65
70	29.3	27.3	22.6	23.8	23.7		19.2	19.2		16.3			15.9			70
75	28.9	26.9	22	23.6	23.3	22.5	19.1	18.8		16.1	16		15.8	15.7		75
80	28.5	26.4	21.5	23.2	22.8	22.1	18.9	18.4	17.8	15.9	15.8		15.6	15.5		80
85	28.1	25.6	21.1	22.6	22.3	21.6	18.7	17.9	17.4	15.7	15.5	15.1	15.4	15.2	15	85
90	27.4	24.8	20.8	22.1	21.7	21.2	18.2	17.5	16.9	15.5	15.1	14.7	15.2	15	14.6	90
95	26.7	24.1	20.5	21.5	21.1	20.7	17.9	17	16.4	15.1	14.8	14.4	14.9	14.6	14.2	95
100	25.8	23.4	20.2	20.8	20.4	20.3	17.4	16.6	16	14.7	14.4	14	14.5	14.3	13.9	100
105	24.9	22.8	19.9	20.2	19.8	19.7	17	16.1	15.6	14.3	14.1	13.7	14.1	13.9	13.6	105
110	24	22.2	19.4	19.5	19.1	19.1	16.5	15.7	15.2	13.9	13.7	13.4	13.8	13.6	13.3	110
115	23.2	21.7	18.8	18.9	18.5	18.5	16.1	15.3	14.9	13.5	13.3	13	13.4	13.2	12.9	115
120	22.4	21.1	18.2	18.2	17.9	17.9	15.6	14.9	14.5	13.1	12.9	12.7	12.9	12.8	12.6	120
125	21.5	20.7	17.6	17.6	17.3	17.3	15.1	14.6	14.2	12.6	12.5	12.4	12.5	12.4	12.3	125
130	20.7	20.1	17.3	17	16.8	16.7	14.6	14.2	13.9	12.2	12.1	12.1	12.1	12	12.1	130
135	19.9	19.6	17.2	16.4	16.2	16.2	14.1	13.8	13.5	11.8	11.7	11.8	11.7	11.6	11.7	135
140	19.1	19	17.1	15.9	15.7	15.7	13.7	13.4	13.2	11.4	11.3	11.4	11.3	11.2	11.4	140
145	18.3	18.3	17.1	15.4	15.2	15.2	13.2	13	12.9	11	10.9	11	10.9	10.9	11	145
150	17.5	17.7	17	14.9	14.7	14.7	12.8	12.7	12.6	10.6	10.6	10.7	10.6	10.5	10.6	150
155	16.7	17.1	16.8	14.4	14.3	14.3	12.4	12.3	12.3	10.3	10.2	10.3	10.2	10.2	10.3	155
160	16	16.4	16.3	13.9	13.8	13.8	12	11.9	12	9.9	9.9	10	9.8	9.8	9.9	160
165	15.3	15.6	15.7	13.5	13.3	13.4	11.6	11.6	11.6	9.6	9.5	9.6	9.5	9.5	9.6	165
170	14.6	14.9	15.2	13	12.9	13	11.2	11.2	11.3	9.2	9.2	9.3	9.2	9.2	9.3	170
175	13.9	14.2	14.5	12.5	12.5	12.6	10.9	10.8	10.9	8.9	8.9	9	8.9	8.9	9	175
180	13.2	13.6	13.9	12.1	12.1	12.2	10.5	10.5	10.6	8.6	8.6	8.7	8.6	8.6	8.7	180
185	12.6	13	13.2	11.6	11.7	11.8	10.2	10.2	10.3	8.3	8.3	8.4	8.3	8.3	8.4	185
190	12	12.3	12.6	11.1	11.3	11.5	9.8	9.8	9.9	8	8	8.1	8	8	8.1	190
195	11.2	11.7	11.9	10.7	10.9	11.1	9.5	9.5	9.6	7.8	7.8	7.9	7.7	7.8	7.9	195
200	10.3	11	10.7	10.2	10.4	10.7	9.2	9.2	9.3	7.5	7.5	7.6	7.4	7.5	7.6	200
205	9.8	10.1	8.3	9.7	10	10.2	8.9	8.9	9	7.3	7.3	7.4	7.1	7.3	7.4	205
210	9.5	9.5	6.7	9.2	9.5	9.7	8.6	8.7	8.8	7.1	7	7.1	6.8	7.1	7.1	210
215	9.1	9.2	5.5	8.7	9	9.2	8.3	8.4	8.5	6.8	6.8	6.9	6.5	6.8	6.8	215
220	8.7	8.8		7.9	8.4	7.6	7.9	8.1	8.2	6.6	6.6	6.7	6.2	6.4	6.5	220
225	8.4	8.5		7.6	7.7	6.3	7.6	7.8	7.9	6.4	6.4	6.5	5.9	6.1	6.2	225
230	7	8.2		7.4	7.4	5.3	7.2	7.5	7.6	6.2	6.2	6.3	5.5	5.7	5.9	230
235	5.6	6.6		7.1	7.2		6.8	7.1	7	6	6	6.1	5.1	5.4	5.5	235
240				6.9	6.9		6.3	6.6	6	5.8	5.8	5.9	4.8	5	5.1	240
245				6.1	6.8		5.8	6.1	5.1	5.5	5.6	5.7	4.4	4.7	4.7	245
250				3.5	4.8		5.1	5.5		5.2	5.4	5.5	4.1	4.3	4.4	250
255							4.6	4.9		4.6	5	5.1	3.8	4	4	255
260							3.2	4.3		4	4.4		3.5	3.7	3.7	260
265										3.4	3.8		3.2	3.4		265
270										2.8	3.2		2.7	3		270
275														2.4		275

t_240_002_56101_00_000

Lifting capacities Forces de levage

TNZK

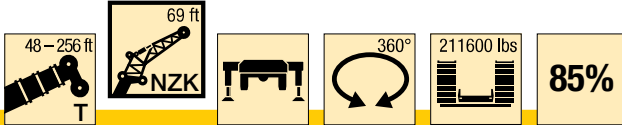

ft	48 ft			144 ft			160 ft			176 ft			192 ft			ft
	69 ft			69 ft			69 ft			69 ft			69 ft			
	0°	20°	40°	0°	20°	40°	0°	20°	40°	0°	20°	40°	0°	20°	40°	
12	20.8															12
13	20.8															13
14	20.9															14
15	21															15
16	21															16
17	21															17
18	21															18
19	21															19
20	21															20
22	21															22
24	20.9															24
26	20.7															26
28	20.5			20.8												28
30	20.3			20.9			19.9									30
32	20			21			19.9									32
34	19.7	17.8		21			19.9			18.7						34
36	19.4	17.5		21			19.9			18.7						36
38	19.1	17.2		21			19.9			18.8			17.4			38
40	18.7	16.9		21			19.9			18.8			17.4			40
45	17.9	16.1		21			19.9			18.8			17.5			45
50	17.1	15.4		20.8			19.9			18.8			17.5			50
55	16.3	14.7	13.2	20.5	17.5		19.8	17.2		18.8			17.5			55
60	15.5	14.1	12.8	20.3	17		19.6	16.8		18.7	16.3		17.5			60
65	14.8	13.6	12.4	19.9	16.7		19.3	16.4		18.5	16		17.3	15.2		65
70	14.2	13.1	12	19.5	16.2	13.4	19	16		18.2	15.6		17.1	15		70
75	13.6	12.6	11.8	19	15.8	13.2	18.6	15.6	13.1	17.9	15.3		16.8	14.7		75
80	13.1	12.3	11.6	18.6	15.4	13	18.2	15.3	12.9	17.6	15	12.7	16.6	14.4		80
85	12.6	12	11.4	18.1	15.1	12.8	17.8	15	12.7	17.2	14.7	12.5	16.3	14.2	12.2	85
90	12.1	11.7	11.4	17.7	14.7	12.6	17.4	14.6	12.5	16.9	14.4	12.3	16	13.9	12.1	90
95	11.6	11.5	11.4	17.2	14.4	12.4	17	14.3	12.3	16.5	14.1	12.2	15.7	13.7	11.9	95
100	11.1	11.4	11.4	16.7	14.1	12.2	16.6	14.1	12.2	16.2	13.9	12	15.4	13.4	11.8	100
105	10.6	11.3	4.5	16.3	13.8	12.1	16.2	13.8	12	15.8	13.6	11.9	15.1	13.2	11.7	105
110	9.8			15.9	13.5	11.9	15.8	13.5	11.9	15.5	13.4	11.7	14.9	13	11.5	110
115				15.5	13.3	11.8	15.5	13.3	11.8	15.2	13.1	11.6	14.6	12.8	11.4	115
120				15.1	13.1	11.7	15.1	13	11.6	14.9	12.9	11.5	14.4	12.6	11.3	120
125				14.7	12.8	11.6	14.8	12.8	11.5	14.6	12.7	11.4	14.1	12.4	11.2	125
130				14.4	12.6	11.5	14.4	12.6	11.4	14.3	12.5	11.4	13.9	12.3	11.1	130
135				14.1	12.4	11.4	14.1	12.4	11.4	14	12.3	11.3	13.6	12.1	11.1	135
140				13.7	12.2	11.4	13.8	12.3	11.3	13.8	12.2	11.2	13.4	11.9	11	140
145				13.4	12.1	11.4	13.6	12.1	11.3	13.5	12	11.2	13.2	11.8	11	145
150				13.1	11.9	11.4	13.3	11.9	11.2	13.2	11.9	11.1	13	11.7	10.9	150
155				12.9	11.8	11.4	13	11.8	11.2	13	11.7	11.1	12.8	11.5	10.9	155
160				12.6	11.7	11.4	12.8	11.7	11.2	12.8	11.6	11.1	12.6	11.4	10.8	160
165				12.3	11.6	11.4	12.5	11.6	11.2	12.5	11.5	11.1	12.4	11.3	10.8	165
170				12	11.5	11.4	12.3	11.5	11.2	12.3	11.4	11.1	12.2	11.2	10.8	170
175				11.8	11.5	11.4	12.1	11.4	11.2	12.1	11.3	11.1	12	11.1	10.8	175
180				11.5	11.4	8.6	11.8	11.3	11.2	12	11.2	11.1	11.8	11.1	10.8	180
185				11.2	11.3	6.2	11.6	11.3	11.2	11.8	11.2	11.1	11.7	11	10.8	185
190				10.9	11.3		11.4	11.3	10.3	11.6	11.1	11.1	11.5	10.9	10.8	190
195				10.6	11.3		11.2	11.2	7.6	11.4	11.1	11.1	11.2	10.9	10.8	195
200				10.2	10.7		11	11.2	5.8	11.3	11.1	11.1	11	10.9	10.8	200
205							10.8	11.2		11.1	11	9.1	10.7	10.9	10.8	205
210							10.5	11.2		10.9	11	7	10.1	10.6	10.8	210
215							7.7	10.6		10.7	10.9	5.4	9.4	10.2	10.3	215
220										10.1	10.7		9	9.4	8.2	220
225										8.8	9.9		8.7	8.8	6.4	225
230										6	8.1		8.3	8.5	5.2	230
235											3		8	8.2		235
240													7	7.9		240
245													5.2	6.5		245
250														5.2		250

t_240_002_56301_00_000

Lifting capacities Forces de levage

TNZK

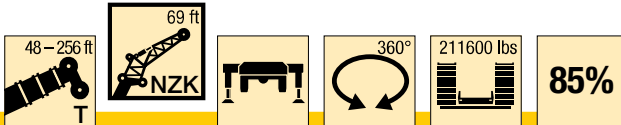

ft	208 ft			224 ft			240 ft			253 ft			256 ft			ft
	69 ft			69 ft			69 ft			69 ft			69 ft			
	0°	20°	40°	0°	20°	40°	0°	20°	40°	0°	20°	40°	0°	20°	40°	
45	15.8															45
50	15.9			14												50
55	15.9			14.1			12.2									55
60	15.8			14.1			12.2			10.6			10.4			60
65	15.7			14			12.2			10.6			10.4			65
70	15.6	14.1		14			12.2			10.7			10.4			70
75	15.5	13.9		13.8			12.1			10.7			10.5			75
80	15.2	13.6		13.7	12.6		12.1			10.7			10.4			80
85	15	13.4		13.6	12.5		12	11.3		10.6			10.4			85
90	14.8	13.2	11.7	13.4	12.3		11.9	11.2		10.6	10.2		10.4	10		90
95	14.6	13	11.5	13.2	12.1	11.1	11.8	11.1		10.5	10.1		10.3	9.9		95
100	14.4	12.8	11.4	13.1	12	11	11.7	11		10.4	10.1		10.3	9.9		100
105	14.2	12.6	11.3	13	11.9	10.9	11.6	10.9	10.3	10.4	10		10.2	9.8		105
110	14	12.4	11.2	12.8	11.7	10.8	11.5	10.8	10.3	10.3	9.9	9.6	10.1	9.8	9.5	110
115	13.8	12.3	11.1	12.7	11.6	10.7	11.4	10.7	10.2	10.2	9.8	9.5	10	9.7	9.4	115
120	13.6	12.1	11	12.5	11.5	10.6	11.2	10.6	10.1	10.1	9.6	9.4	10	9.5	9.3	120
125	13.4	12	11	12.4	11.4	10.6	11.1	10.5	10.1	10	9.4	9.2	9.9	9.4	9.1	125
130	13.2	11.8	10.9	12.2	11.2	10.5	10.9	10.4	10	9.8	9.2	8.9	9.7	9.1	8.9	130
135	13	11.7	10.8	12.1	11.1	10.5	10.8	10.2	9.9	9.5	9	8.7	9.4	8.9	8.7	135
140	12.8	11.5	10.8	11.9	11	10.5	10.6	10	9.7	9.2	8.7	8.5	9.2	8.7	8.5	140
145	12.6	11.4	10.7	11.8	10.9	10.4	10.4	9.8	9.5	9	8.5	8.3	8.9	8.5	8.3	145
150	12.4	11.3	10.7	11.6	10.8	10.4	10.2	9.5	9.3	8.7	8.3	8.1	8.7	8.3	8.1	150
155	12.2	11.2	10.7	11.5	10.7	10.4	10	9.3	9.1	8.5	8.1	7.9	8.4	8.1	7.9	155
160	12.1	11.1	10.6	11.3	10.6	10.3	9.7	9.1	8.9	8.2	7.9	7.8	8.2	7.9	7.8	160
165	11.9	11	10.6	11.1	10.5	10.3	9.5	8.9	8.8	8	7.7	7.6	7.9	7.7	7.6	165
170	11.8	10.9	10.6	10.8	10.4	10.3	9.2	8.7	8.6	7.7	7.6	7.5	7.7	7.5	7.5	170
175	11.6	10.9	10.6	10.5	10.2	10.3	8.9	8.5	8.4	7.4	7.4	7.3	7.4	7.4	7.3	175
180	11.4	10.8	10.6	10.2	10	10.2	8.7	8.3	8.2	7.2	7.2	7.2	7.2	7.2	7.2	180
185	11.1	10.7	10.6	9.9	9.8	10	8.5	8.1	8.1	7	7	7	6.9	7	7	185
190	10.8	10.7	10.6	9.6	9.6	9.8	8.2	8	7.9	6.8	6.8	6.9	6.7	6.8	6.9	190
195	10.6	10.6	10.6	9.3	9.3	9.6	7.9	7.8	7.8	6.6	6.7	6.8	6.5	6.6	6.7	195
200	10.3	10.5	10.6	9.1	9.1	9.3	7.7	7.6	7.6	6.4	6.5	6.6	6.3	6.4	6.6	200
205	9.9	10.2	10.5	8.8	8.8	9	7.5	7.5	7.5	6.2	6.3	6.4	6.2	6.2	6.4	205
210	9.5	9.8	10.2	8.5	8.5	8.7	7.3	7.3	7.4	6	6.1	6.2	6	6	6.2	210
215	9.1	9.5	9.9	8.2	8.3	8.5	7.1	7.1	7.2	5.8	5.9	6	5.8	5.9	6	215
220	8.6	9.1	9.4	7.9	8	8.2	6.9	6.9	7.1	5.6	5.7	5.9	5.6	5.7	5.8	220
225	7.9	8.7	8.9	7.6	7.7	8	6.7	6.8	6.9	5.5	5.5	5.7	5.3	5.5	5.7	225
230	7.3	8.1	8.4	7.3	7.5	7.7	6.5	6.6	6.8	5.3	5.4	5.5	5	5.3	5.5	230
235	7	7.5	7.5	6.9	7.2	7.4	6.3	6.4	6.6	5.1	5.2	5.4	4.7	5.2	5.3	235
240	6.8	7	6.1	6.5	6.9	7.1	6.1	6.3	6.4	5	5	5.2	4.5	5	5.1	240
245	6.6	6.7	5	6.1	6.6	6.8	5.9	6.1	6.2	4.8	4.9	5	4.2	4.7	4.8	245
250	6.4	6.5		5.7	6.2	6.3	5.7	5.9	6.1	4.6	4.7	4.9	3.9	4.4	4.5	250
255	5.7	6.2		5.5	5.7	5.7	5.4	5.7	5.9	4.4	4.6	4.7	3.6	4.1	4.2	255
260	4.9	5.4		5.4	5.4		4.9	5.4	5.6	4.2	4.4	4.5	3.3	3.7	3.9	260
265		3.4		5.2	5.3		4.4	5.1	5.3	4	4.2	4.4	3	3.4	3.5	265
270				4.7	5.1		3.9	4.5	4.6	3.7	4	4.1	2.7	3.1	3.2	270
275				2.8	4.5		3.3	3.9		3.3	3.8	3.9	2.4	2.8	2.9	275
280							2.8	3.4		2.5	3.4	3.5		2.5	2.5	280
285								2.8			2.9	2.9				285

t_240_002_56301_00_000

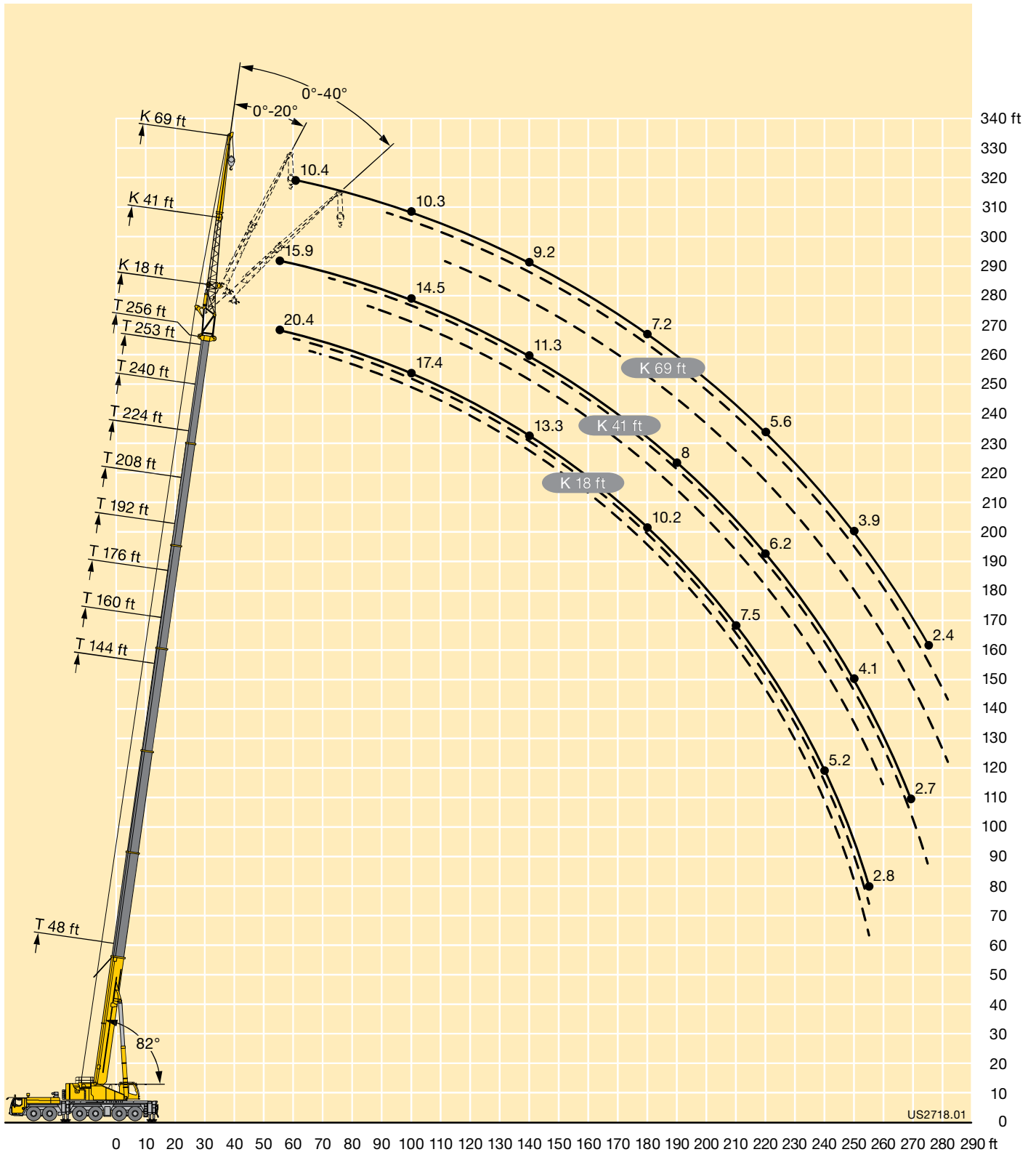

Lifting capacities Forces de levage

TNZK

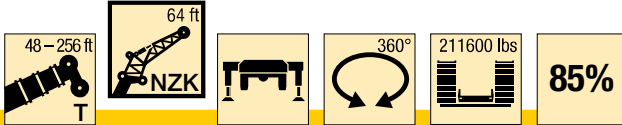

ft	48 ft			144 ft			160 ft			176 ft			192 ft			ft
	64 ft			64 ft			64 ft			64 ft			64 ft			
	0°	20°	40°	0°	20°	40°	0°	20°	40°	0°	20°	40°	0°	20°	40°	
12	31.4															12
13	31.4															13
14	31.4															14
15	31.4															15
16	31.2															16
17	31															17
18	30.7															18
19	30.5															19
20	30.2															20
22	29.6															22
24	29															24
26	28.4															26
28	27.7			31.4												28
30	27.1			31.4			27									30
32	26.4	22.9		31.4			27			24.9						32
34	25.8	22.3		31.3			27			24.9						34
36	25.2	21.6		31.1			27			24.9						36
38	24.6	21		30.9			27			24.9			22.1			38
40	24	20.4		30.6			27			25			22.1			40
45	22.6	19.1		29.8			27			25			22.1			45
50	21.2	17.9	15.1	29	22.7		26.9			25			22.2			50
55	19.7	16.9	14.3	28.1	21.8		26.7	22.3		24.7			22.1			55
60	18.2	16	13.7	27.3	21		26.1	21.7		24.3	20.9		21.9			60
65	16.9	15.2	13.1	26.4	20.3	15.4	25.5	21.2		23.9	20.4		21.6	19.3		65
70	15.6	14.5	12.6	25.6	19.6	15	25	20.6	15.9	23.4	19.9		21.3	18.9		70
75	14.5	13.8	12.2	24.8	18.9	14.6	24.3	20.1	15.7	23	19.5	15.5	21	18.6		75
80	13.6	13.2	11.9	24	18.3	14.3	23.7	19.6	15.4	22.5	19.1	15.2	20.7	18.2	14.9	80
85	12.7	12.7	11.7	23.2	17.8	14	23.1	19.1	15.1	22.1	18.7	14.9	20.4	17.9	14.6	85
90	11.9	12.2	11.6	22.4	17.2	13.7	22.5	18.6	14.8	21.6	18.2	14.7	20	17.5	14.4	90
95	11.3	11.8	11.6	21.7	16.7	13.4	21.9	18.1	14.5	21.1	17.8	14.4	19.7	17.2	14.2	95
100	10.7	11.6	5.1	20.9	16.2	13.1	21.4	17.6	14.3	20.7	17.4	14.2	19.4	16.8	14	100
105	10.3			20.1	15.8	12.9	20.8	17.1	14.1	20.2	17	14	19.1	16.5	13.8	105
110				19.3	15.4	12.7	20.3	16.7	13.9	19.8	16.6	13.8	18.8	16.2	13.6	110
115				18.5	15	12.5	19.8	16.3	13.7	19.4	16.2	13.6	18.4	15.9	13.4	115
120				17.7	14.7	12.3	19.3	15.9	13.5	18.9	15.9	13.4	18.1	15.5	13.2	120
125				17	14.3	12.1	18.8	15.6	13.3	18.5	15.6	13.3	17.8	15.2	13.1	125
130				16.3	14	12	18.3	15.3	13.2	18.1	15.2	13.1	17.5	15	13	130
135				15.6	13.7	11.9	17.8	14.9	13	17.7	15	13	17.2	14.7	12.8	135
140				15	13.4	11.8	17.3	14.6	12.9	17.3	14.7	12.9	16.8	14.4	12.8	140
145				14.5	13.1	11.7	16.9	14.3	12.8	16.9	14.4	12.8	16.5	14.2	12.7	145
150				14	12.9	11.7	16.4	14	12.8	16.5	14.1	12.7	16.2	14	12.6	150
155				13.5	12.6	11.6	15.9	13.8	12.7	16.1	13.9	12.7	15.8	13.7	12.5	155
160				13	12.3	11.6	15.4	13.5	12.6	15.7	13.6	12.6	15.5	13.5	12.5	160
165				12.5	12.1	11.6	14.9	13.3	12.6	15.3	13.3	12.6	15.1	13.3	12.4	165
170				12.1	12	11.6	14.4	13	12.6	14.9	13.1	12.5	14.7	13.1	12.4	170
175				11.8	11.8	8.6	13.9	12.8	12.6	14.5	12.9	12.5	14.2	12.9	12.3	175
180				11.4	11.7	6.3	13.5	12.6	12.6	14.1	12.7	12.5	13.8	12.7	12.3	180
185				11.1	11.6		13.1	12.5	10.6	13.7	12.5	12.4	13.3	12.5	12.3	185
190				10.8	11.6		12.7	12.3	7.6	13.3	12.4	12.4	12.7	12.2	12.3	190
195				10.5	11.1		12.3	12.3	5.8	12.8	12.3	11.8	12.2	12	12.3	195
200							12	12.2		12.4	12.2	9.1	11.3	11.8	12	200
205							11.5	12.2		11.9	11.9	7	10.5	11.4	11.6	205
210							8.2	10.9		11.2	11.5	5.5	9.7	10.6	10.6	210
215								3.8		10.5	11		9.4	9.7	8.2	215
220										9.3	10.2		9	9.2	6.5	220
225										6.3	8.4		8.7	8.8	5.2	225
230											3.4		8.3	8.5		230
235													7.4	8.1		235
240													5.4	6.8		240
245													4.1	5.4		245

t_240_002_56201_00_000

Lifting capacities Forces de levage

TNZK

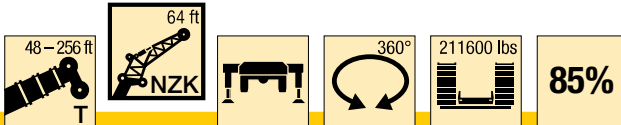

ft	208 ft			224 ft			240 ft			253 ft			256 ft			ft
	64 ft			64 ft			64 ft			64 ft			64 ft			
	0°	20°	40°	0°	20°	40°	0°	20°	40°	0°	20°	40°	0°	20°	40°	
45	19.2															45
50	19.2			16.4												50
55	19.3			16.4			13.8									55
60	19.2			16.4			13.9			11.9			11.6			60
65	19.1			16.4			13.9			11.9			11.6			65
70	18.9	17.5		16.4			13.9			12			11.7			70
75	18.7	17.2		16.3	15.5		13.9			12			11.7			75
80	18.5	17		16.2	15.4		13.8			11.8			11.6			80
85	18.3	16.7	14.2	16	15.2		13.7	13.2		11.7			11.5			85
90	18.1	16.5	14	15.9	15.1		13.6	13.2		11.6	11.2		11.4	10.9		90
95	17.9	16.2	13.8	15.7	14.9	13.1	13.5	13.1		11.5	11.2		11.3	10.9		95
100	17.7	15.9	13.6	15.6	14.8	13	13.3	12.9	12.1	11.4	11.1		11.2	10.8		100
105	17.4	15.7	13.4	15.4	14.6	12.9	13.2	12.6	12	11.2	10.9	10.5	11.1	10.7	10.4	105
110	17.2	15.4	13.2	15.2	14.4	12.7	13	12.2	11.7	11.1	10.6	10.2	10.9	10.5	10.2	110
115	17	15.2	13.1	15	14.2	12.6	12.8	11.9	11.4	10.9	10.3	10	10.7	10.2	9.9	115
120	16.8	14.9	13	14.8	14	12.5	12.5	11.6	11.2	10.7	10.1	9.7	10.6	10	9.7	120
125	16.6	14.7	12.8	14.6	13.8	12.4	12.2	11.3	10.9	10.5	9.8	9.5	10.4	9.7	9.4	125
130	16.3	14.4	12.7	14.3	13.6	12.3	11.8	11	10.6	10.2	9.6	9.3	10.1	9.5	9.2	130
135	16.1	14.2	12.6	14	13.4	12.2	11.5	10.7	10.4	9.9	9.3	9	9.8	9.2	9	135
140	15.9	14	12.5	13.7	13.2	12.2	11.2	10.5	10.1	9.6	9.1	8.8	9.5	9	8.8	140
145	15.6	13.8	12.4	13.2	12.9	12.1	10.9	10.2	9.9	9.3	8.9	8.6	9.2	8.8	8.6	145
150	15.2	13.6	12.4	12.8	12.6	12	10.6	9.9	9.7	9	8.6	8.4	8.9	8.6	8.4	150
155	14.8	13.4	12.3	12.4	12.2	11.9	10.4	9.7	9.5	8.7	8.4	8.2	8.6	8.4	8.2	155
160	14.3	13.1	12.2	12	11.8	11.7	10.1	9.5	9.2	8.4	8.2	8	8.3	8.2	8	160
165	13.9	12.9	12.2	11.6	11.5	11.5	9.8	9.2	9	8.1	8	7.8	8.1	7.9	7.8	165
170	13.4	12.7	12.1	11.2	11.1	11.2	9.5	9	8.9	7.8	7.8	7.7	7.8	7.7	7.7	170
175	13	12.5	12.1	10.9	10.8	10.9	9.2	8.8	8.7	7.5	7.5	7.5	7.5	7.5	7.5	175
180	12.5	12.2	12	10.5	10.5	10.6	9	8.6	8.5	7.2	7.3	7.3	7.2	7.3	7.3	180
185	12	11.9	11.9	10.1	10.1	10.3	8.7	8.4	8.3	7	7.1	7.2	7	7.1	7.1	185
190	11.4	11.6	11.7	9.8	9.8	10	8.4	8.2	8.2	6.8	6.9	7	6.8	6.9	7	190
195	10.9	11.3	11.6	9.5	9.5	9.7	8.1	8	8	6.6	6.7	6.8	6.6	6.7	6.8	195
200	10.4	10.9	11.1	9.2	9.2	9.4	7.8	7.9	7.9	6.4	6.5	6.6	6.4	6.5	6.6	200
205	10	10.4	10.7	8.9	8.9	9.1	7.6	7.6	7.7	6.2	6.3	6.4	6.2	6.3	6.4	205
210	9.5	9.9	10.2	8.6	8.6	8.8	7.4	7.4	7.5	6	6.1	6.2	6	6.1	6.2	210
215	8.9	9.5	9.7	8.3	8.3	8.6	7.2	7.2	7.3	5.8	5.9	6	5.8	5.9	6	215
220	8.3	9	9.2	7.9	8	8.3	7	7	7.1	5.7	5.7	5.9	5.5	5.7	5.9	220
225	7.6	8.4	8.6	7.6	7.7	8	6.7	6.8	6.9	5.5	5.5	5.7	5.2	5.5	5.7	225
230	7.3	7.7	7.5	7.2	7.4	7.7	6.5	6.6	6.8	5.3	5.4	5.5	4.9	5.3	5.5	230
235	7	7.1	6.1	6.8	7.1	7.3	6.3	6.4	6.6	5.2	5.2	5.3	4.6	5.1	5.3	235
240	6.8	6.9	5	6.3	6.8	7	6.1	6.3	6.4	5	5	5.2	4.3	4.8	5	240
245	6.6	6.6		5.9	6.3	6.5	5.8	6.1	6.2	4.8	4.9	5	4.1	4.5	4.7	245
250	6	6.4		5.7	5.8	5.8	5.6	5.9	6.1	4.6	4.7	4.9	3.8	4.2	4.4	250
255	5	5.6		5.5	5.6		5.1	5.6	5.8	4.4	4.6	4.7	3.5	3.8	4	255
260		3.6		5.4	5.4		4.6	5.3	5.4	4.1	4.4	4.5	3.2	3.5	3.7	260
265				4.9	5.3		4	4.7	4.8	3.8	4.1	4.3	2.9	3.2	3.3	265
270				3	4.6		3.5	4.1		3.3	3.9	4	2.6	2.9	3	270
275							3	3.5			3.5	3.6		2.6	2.6	275
280								2.9			2.5	2.6				280

t_240_002_56201_00_000

Lifting capacities Forces de levage

TNZK

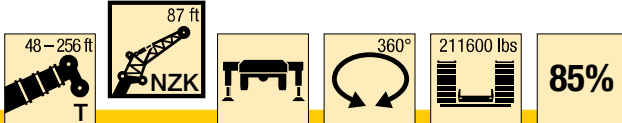

ft	48 ft			144 ft			160 ft			176 ft			192 ft			ft
	87 ft			87 ft			87 ft			87 ft			87 ft			
	0°	20°	40°	0°	20°	40°	0°	20°	40°	0°	20°	40°	0°	20°	40°	
14	19.4															14
15	19.4															15
16	19.4															16
17	19.4															17
18	19.4															18
19	19.5															19
20	19.4															20
22	19.3															22
24	19.1															24
26	18.9															26
28	18.5															28
30	18.2															30
32	17.8			19.4												32
34	17.5			19.4			18									34
36	17.1			19.5			18.1									36
38	16.8			19.5			18.1			16.5						38
40	16.4			19.4			18.1			16.6						40
45	15.6	13.5		19.2			18.1			16.6			14.9			45
50	14.8	12.7		18.8			17.8			16.5			15			50
55	14	11.9		18.3			17.5			16.4			14.9			55
60	13.1	11.2		17.8			17			16.1			14.7			60
65	12.4	10.6	8.9	17.2	13.4		16.6	13.1		15.7			14.5			65
70	11.6	10	8.5	16.7	12.9		16.2	12.7		15.4	12.4		14.3			70
75	10.9	9.5	8.1	16.2	12.4		15.8	12.3		15	12		14	11.6		75
80	10.3	9	7.8	15.7	12		15.3	11.9		14.7	11.7		13.7	11.3		80
85	9.7	8.5	7.5	15.2	11.5	8.7	14.9	11.5		14.3	11.3		13.4	11		85
90	9.1	8.2	7.3	14.8	11.1	8.5	14.5	11.1	8.5	14	11	8.4	13.2	10.7		90
95	8.6	7.8	7.1	14.3	10.8	8.3	14.1	10.8	8.3	13.6	10.7	8.2	12.9	10.4	8	95
100	8.2	7.5	6.9	13.8	10.5	8.1	13.7	10.5	8.1	13.3	10.4	8	12.6	10.1	7.9	100
105	7.8	7.3	6.8	13.3	10.1	8	13.3	10.2	7.9	13	10.1	7.9	12.3	9.8	7.8	105
110	7.3	7	6.8	12.9	9.8	7.8	12.9	9.9	7.8	12.6	9.8	7.7	12.1	9.6	7.6	110
115	7	6.9	6.8	12.4	9.5	7.6	12.5	9.6	7.6	12.3	9.6	7.6	11.8	9.3	7.5	115
120	6.7	6.8	6.8	12	9.3	7.5	12.1	9.3	7.5	12	9.3	7.5	11.5	9.1	7.4	120
125	6.5	6.8		11.5	9	7.4	11.7	9.1	7.4	11.6	9	7.3	11.3	8.9	7.3	125
130				11.1	8.8	7.3	11.4	8.8	7.3	11.3	8.8	7.2	11	8.7	7.2	130
135				10.7	8.5	7.2	11	8.6	7.2	11	8.6	7.1	10.7	8.5	7.1	135
140				10.3	8.3	7.1	10.6	8.4	7.1	10.7	8.4	7	10.4	8.3	7	140
145				10	8.1	7	10.2	8.2	7	10.4	8.2	7	10.2	8.2	6.9	145
150				9.6	7.9	6.9	9.9	8	6.9	10.1	8.1	6.9	9.9	8	6.8	150
155				9.3	7.8	6.9	9.6	7.9	6.9	9.8	7.9	6.8	9.7	7.8	6.8	155
160				9	7.6	6.8	9.3	7.7	6.8	9.5	7.7	6.8	9.4	7.7	6.7	160
165				8.8	7.4	6.8	9	7.6	6.8	9.2	7.6	6.7	9.2	7.5	6.7	165
170				8.5	7.3	6.8	8.8	7.4	6.8	9	7.4	6.7	8.9	7.4	6.6	170
175				8.2	7.2	6.8	8.5	7.3	6.7	8.7	7.3	6.7	8.7	7.3	6.6	175
180				7.9	7.1	6.8	8.3	7.2	6.7	8.5	7.2	6.6	8.5	7.2	6.6	180
185				7.7	7	6.8	8.1	7.1	6.7	8.2	7.1	6.6	8.3	7.1	6.6	185
190				7.5	6.9	6.8	7.9	7	6.7	8	7	6.6	8.1	7	6.5	190
195				7.2	6.9	6.8	7.6	6.9	6.7	7.9	6.9	6.6	7.9	6.9	6.5	195
200				7	6.8	6.8	7.4	6.8	6.7	7.7	6.9	6.6	7.7	6.8	6.5	200
205				6.9	6.8	5.4	7.3	6.8	6.7	7.5	6.8	6.6	7.6	6.8	6.5	205
210				6.7	6.8		7.1	6.8	6.7	7.4	6.7	6.6	7.5	6.7	6.5	210
215				6.6	6.8		6.9	6.8	6.5	7.2	6.7	6.6	7.3	6.7	6.5	215
220				6.1	6.8		6.8	6.8	5.1	7.1	6.7	6.6	7.2	6.6	6.5	220
225							6.6	6.8		6.9	6.7	6.6	7.1	6.6	6.5	225
230							6.5	6.8		6.8	6.6	6.2	6.9	6.6	6.5	230
235							4.4	6.6		6.6	6.6		6.8	6.6	6.5	235
240										6.6	6.6		6.7	6.6	6.5	240
245										5.7	6.6		6.6	6.6	5.9	245
250										2.8	5.1		6.5	6.5		250
255													6.2	6.4		255
260													4.4	6.2		260
265													3.9	4		265

t_240_002_56401_00_000

Lifting capacities Forces de levage

TNZK

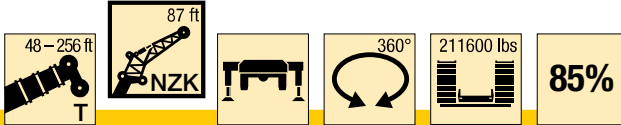

ft	208 ft			224 ft			240 ft			253 ft			256 ft			ft
	87 ft			87 ft			87 ft			87 ft			87 ft			
	0°	20°	40°	0°	20°	40°	0°	20°	40°	0°	20°	40°	0°	20°	40°	
50	13.1															50
55	13.1			11.2												55
60	13.1			11.3			9.4									60
65	13			11.3			9.5			7.8			7.5			65
70	12.9			11.2			9.5			8.1			7.8			70
75	12.7			11.1			9.5			8.2			7.9			75
80	12.5	10.6		11			9.5			8.2			7.9			80
85	12.3	10.4		10.9			9.4			8.1			7.9			85
90	12.1	10.1		10.8	9.4		9.3			8			7.8			90
95	11.9	9.9		10.6	9.2		9.2	8.4		7.9			7.7			95
100	11.7	9.7		10.5	9		9.1	8.3		7.8	7.4		7.7			100
105	11.4	9.4	7.6	10.3	8.8		9	8.1		7.8	7.3		7.6	7.3		105
110	11.2	9.2	7.4	10.2	8.7	7.1	8.9	8		7.7	7.3		7.6	7.3		110
115	11	9	7.3	10	8.5	7.1	8.8	7.9	6.7	7.7	7.3		7.5	7.2		115
120	10.8	8.8	7.2	9.9	8.4	7	8.7	7.7	6.7	7.6	7.2		7.5	7.1		120
125	10.6	8.6	7.1	9.7	8.2	6.9	8.6	7.6	6.7	7.6	7.1	6.4	7.5	7	6.4	125
130	10.4	8.5	7	9.6	8	6.8	8.5	7.5	6.6	7.6	7	6.4	7.4	6.9	6.3	130
135	10.2	8.3	7	9.4	7.9	6.8	8.4	7.4	6.5	7.5	6.9	6.3	7.4	6.9	6.3	135
140	10	8.1	6.9	9.3	7.8	6.7	8.3	7.3	6.5	7.4	6.8	6.3	7.2	6.8	6.2	140
145	9.8	8	6.8	9.1	7.6	6.7	8.2	7.2	6.4	7.2	6.8	6.2	7.1	6.7	6.2	145
150	9.5	7.8	6.7	9	7.5	6.6	8.1	7.1	6.4	7.1	6.7	6.2	7	6.6	6.2	150
155	9.3	7.7	6.7	8.8	7.4	6.5	8	7	6.4	6.9	6.6	6.1	6.9	6.5	6.1	155
160	9.1	7.5	6.6	8.6	7.3	6.5	7.8	6.9	6.3	6.8	6.4	6.1	6.7	6.4	6.1	160
165	8.9	7.4	6.6	8.5	7.2	6.5	7.6	6.8	6.3	6.7	6.3	6	6.6	6.3	6	165
170	8.7	7.3	6.5	8.3	7.1	6.4	7.4	6.7	6.2	6.5	6.2	6	6.4	6.1	5.9	170
175	8.5	7.2	6.5	8.1	7	6.4	7.3	6.7	6.2	6.3	6	5.9	6.3	6	5.9	175
180	8.3	7.1	6.5	8	6.9	6.4	7.1	6.6	6.2	6.1	5.9	5.8	6.1	5.9	5.8	180
185	8.1	7	6.4	7.8	6.8	6.3	6.9	6.5	6.2	6	5.7	5.7	5.9	5.7	5.7	185
190	8	6.9	6.4	7.7	6.7	6.3	6.8	6.4	6.2	5.8	5.6	5.6	5.7	5.6	5.5	190
195	7.8	6.8	6.4	7.5	6.7	6.3	6.6	6.3	6.1	5.6	5.5	5.5	5.5	5.5	5.4	195
200	7.7	6.7	6.4	7.4	6.6	6.3	6.5	6.2	6.1	5.4	5.4	5.4	5.3	5.4	5.3	200
205	7.5	6.7	6.4	7.2	6.5	6.3	6.3	6	6	5.2	5.3	5.3	5.2	5.3	5.2	205
210	7.4	6.6	6.4	7.1	6.5	6.3	6.2	5.9	5.9	5	5.1	5.2	5	5.1	5.2	210
215	7.2	6.6	6.4	6.9	6.5	6.3	6.1	5.8	5.8	4.8	5	5.1	4.8	5	5.1	215
220	7.1	6.5	6.4	6.8	6.4	6.3	5.9	5.7	5.7	4.6	4.8	5	4.6	4.8	4.9	220
225	6.9	6.5	6.4	6.6	6.4	6.3	5.8	5.6	5.6	4.5	4.7	4.8	4.5	4.7	4.8	225
230	6.8	6.5	6.4	6.5	6.3	6.3	5.6	5.5	5.6	4.3	4.5	4.7	4.3	4.5	4.7	230
235	6.7	6.4	6.4	6.3	6.2	6.3	5.4	5.4	5.5	4.1	4.3	4.6	4.1	4.3	4.6	235
240	6.4	6.4	6.4	6	6.1	6.3	5.3	5.3	5.4	3.9	4.2	4.4	3.8	4.1	4.4	240
245	6	6.3	6.4	5.8	6	6.2	5.1	5.2	5.3	3.8	4	4.3	3.6	4	4.3	245
250	5.6	6.1	6.4	5.5	5.8	6.1	4.9	5	5.2	3.6	3.9	4.1	3.3	3.8	4.1	250
255	5.4	5.8	6	5.1	5.6	5.8	4.7	4.9	5.1	3.5	3.7	3.9	3	3.6	3.9	255
260	5.2	5.4	5.5	4.6	5.4	5.5	4.5	4.8	4.9	3.3	3.6	3.8	2.8	3.3	3.7	260
265	5.1	5.2		4.4	5	5.2	4.2	4.6	4.8	3.1	3.4	3.6		3.1	3.3	265
270	4.9	5		4.2	4.4	4.6	3.9	4.5	4.6		3.2	3.4		2.8	3	270
275	3.7	4.8		4.1	4.2	4.4	3.4	4.2	4.4		3	3.2		2.5	2.7	275
280		3.6		4	4.1		2.8	3.8	4		2.8	3			2.3	280
285				3.8	3.9			3.3	3.4			2.6				285
290				2.3	3.8			2.4	2.5							290

t_240_002_56401_00_000

Lifting heights Hauteurs de levage

TNZK

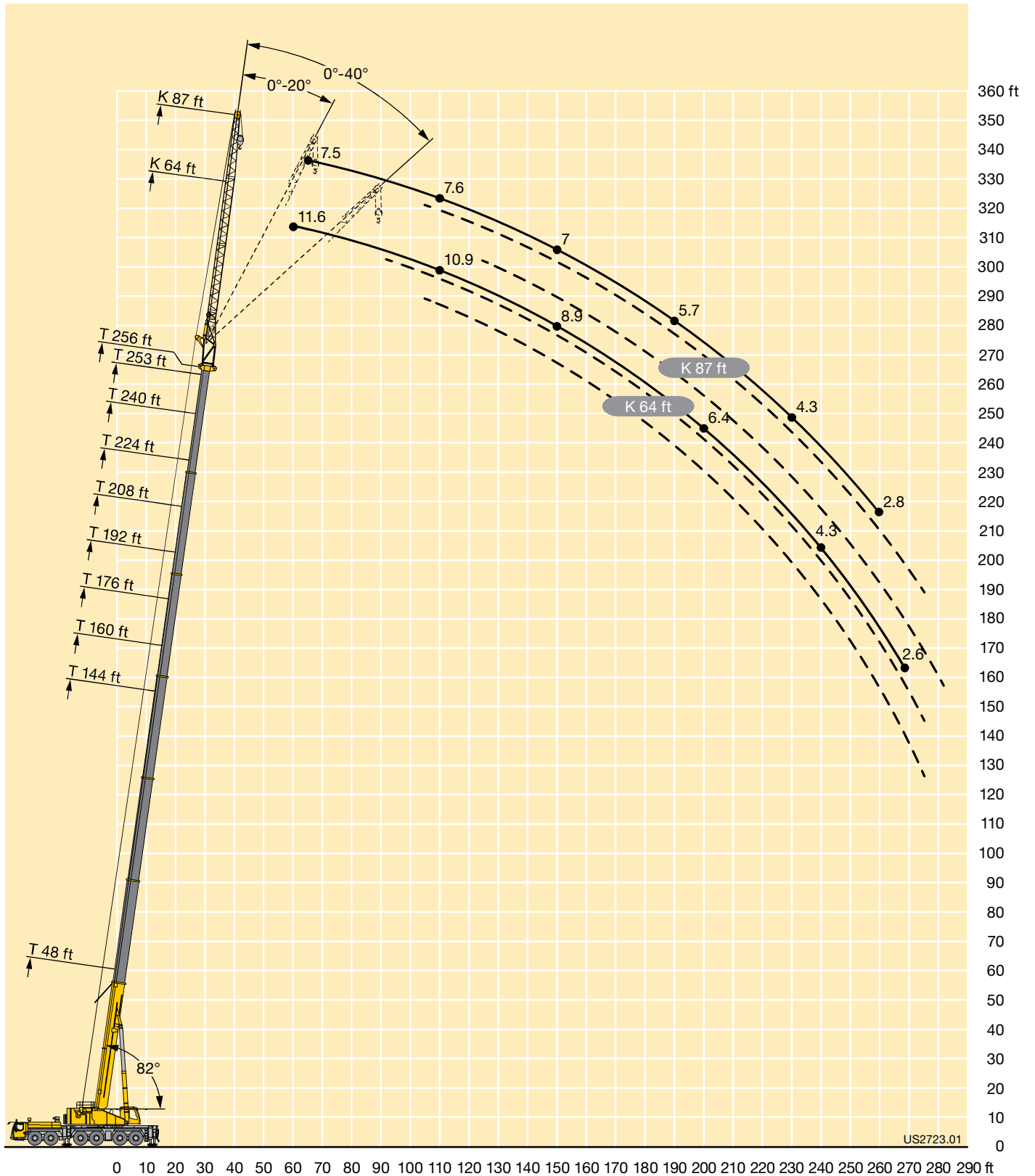

Lifting capacities Forces de levage

TNZK

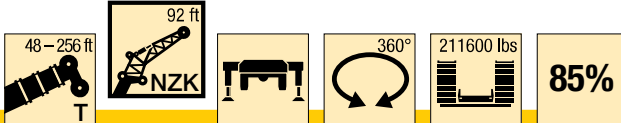

ft	48 ft			144 ft			160 ft			176 ft			192 ft			ft
	92 ft			92 ft			92 ft			92 ft			92 ft			
	0°	20°	40°	0°	20°	40°	0°	20°	40°	0°	20°	40°	0°	20°	40°	
15	15.9															15
16	15.9															16
17	15.9															17
18	15.9															18
19	15.9															19
20	16															20
22	15.9															22
24	15.9															24
26	15.8															26
28	15.6															28
30	15.4															30
32	15.2			15.4												32
34	15			15.8												34
36	14.8			15.9			14.9									36
38	14.5			16			15.1									38
40	14.3			15.9			15.2			14.1						40
45	13.7			15.9			15.2			14.2			12.9			45
50	13.1	11.6		15.7			15			14.2			13			50
55	12.5	10.9		15.4			14.8			14			13			55
60	11.9	10.3		15.1			14.6			13.8			12.9			60
65	11.2	9.7		14.8	12		14.3			13.6			12.7			65
70	10.6	9.2	7.8	14.4	11.6		14	11.5		13.3			12.5			70
75	10.1	8.8	7.5	14.1	11.2		13.7	11.1		13.1	10.9		12.3			75
80	9.5	8.3	7.2	13.7	10.8		13.4	10.7		12.8	10.5		12.1	10.2		80
85	9	8	7	13.4	10.5		13.1	10.4		12.6	10.2		11.9	9.9		85
90	8.5	7.6	6.8	13	10.1	7.8	12.8	10.1	7.8	12.3	9.9		11.6	9.7		90
95	8.1	7.3	6.7	12.6	9.8	7.6	12.5	9.8	7.6	12.1	9.7	7.5	11.4	9.4		95
100	7.7	7	6.5	12.3	9.5	7.5	12.2	9.5	7.4	11.8	9.4	7.4	11.2	9.2	7.2	100
105	7.3	6.8	6.4	11.9	9.2	7.3	11.9	9.3	7.3	11.5	9.1	7.2	11	8.9	7.1	105
110	7	6.6	6.3	11.5	9	7.2	11.5	9	7.2	11.3	8.9	7.1	10.8	8.7	7	110
115	6.7	6.5	6.3	11.2	8.7	7.1	11.2	8.8	7.1	11	8.7	7	10.6	8.5	6.9	115
120	6.5	6.4	6.3	10.8	8.5	7	10.9	8.5	6.9	10.7	8.5	6.9	10.4	8.3	6.8	120
125	6.2	6.3	6.3	10.5	8.2	6.9	10.6	8.3	6.8	10.4	8.3	6.8	10.1	8.1	6.7	125
130	6	6.3		10.1	8	6.8	10.3	8.1	6.7	10.2	8.1	6.7	9.9	8	6.6	130
135				9.8	7.8	6.7	9.9	7.9	6.7	9.9	7.9	6.6	9.7	7.8	6.6	135
140				9.4	7.6	6.6	9.7	7.7	6.6	9.7	7.7	6.6	9.4	7.6	6.5	140
145				9.1	7.4	6.5	9.3	7.5	6.5	9.4	7.5	6.5	9.2	7.5	6.4	145
150				8.8	7.3	6.5	9.1	7.4	6.4	9.1	7.4	6.4	9	7.3	6.4	150
155				8.5	7.2	6.4	8.8	7.2	6.4	8.9	7.3	6.4	8.8	7.2	6.3	155
160				8.3	7	6.4	8.6	7.1	6.3	8.6	7.1	6.3	8.6	7	6.3	160
165				8	6.9	6.3	8.3	7	6.3	8.4	7	6.2	8.4	6.9	6.2	165
170				7.8	6.8	6.3	8.1	6.9	6.3	8.2	6.9	6.2	8.2	6.8	6.1	170
175				7.6	6.7	6.3	7.8	6.7	6.2	8	6.8	6.2	7.9	6.7	6.1	175
180				7.4	6.6	6.3	7.6	6.7	6.2	7.8	6.7	6.1	7.8	6.6	6.1	180
185				7.2	6.5	6.3	7.5	6.6	6.2	7.6	6.6	6.1	7.6	6.6	6.1	185
190				7	6.4	6.3	7.3	6.5	6.2	7.4	6.5	6.1	7.4	6.5	6	190
195				6.8	6.4	6.3	7.1	6.4	6.2	7.2	6.4	6.1	7.3	6.4	6	195
200				6.7	6.3	6.3	7	6.4	6.2	7.1	6.4	6.1	7.1	6.4	6	200
205				6.5	6.3	6.3	6.8	6.3	6.2	7	6.3	6.1	7	6.3	6	205
210				6.4	6.3	5.4	6.7	6.3	6.2	6.8	6.3	6.1	6.9	6.2	6	210
215				6.2	6.3		6.6	6.2	6.2	6.7	6.2	6.1	6.8	6.2	6	215
220				6.1	6.3		6.4	6.2	6.2	6.6	6.2	6.1	6.7	6.1	6	220
225				5.7	6.3		6.3	6.2	5.1	6.5	6.2	6.1	6.6	6.1	6	225
230							6.2	6.2		6.4	6.2	6.1	6.5	6.1	6	230
235							6.1	6.2		6.3	6.2	6	6.4	6.1	6	235
240							4.1	6.2		6.2	6.2		6.3	6.1	6	240
245										6.1	6.2		6.2	6.1	6	245
250										5.4	6.2		6.1	6.1	5.7	250
255										2.6	4.9		6	6		255
260													5.9	6		260
265													4.1	6		265
270													3.8	3.9		270

t_240_002_56501_00_000

Lifting capacities Forces de levage

TNZK

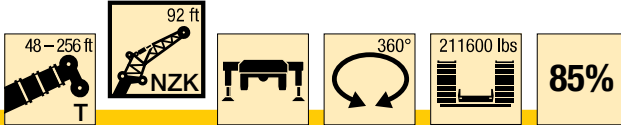

ft	208 ft			224 ft			240 ft			253 ft			256 ft			ft
	92 ft			92 ft			92 ft			92 ft			92 ft			
	0°	20°	40°	0°	20°	40°	0°	20°	40°	0°	20°	40°	0°	20°	40°	
50	11.5															50
55	11.5			9.9												55
60	11.5			10.1			8.2									60
65	11.5			10.2			8.5			6.9						65
70	11.4			10.1			8.7			7.2			6.9			70
75	11.2			10			8.7			7.4			7.2			75
80	11.1			9.9			8.6			7.5			7.3			80
85	10.9	9.4		9.8			8.5			7.5			7.4			85
90	10.7	9.2		9.7	8.5		8.4			7.5			7.3			90
95	10.6	9		9.6	8.4		8.4			7.4			7.3			95
100	10.4	8.8		9.4	8.2		8.3	7.5		7.4			7.3			100
105	10.3	8.6		9.3	8.1		8.2	7.4		7.3	6.9		7.2	6.8		105
110	10.1	8.4	6.9	9.2	7.9		8.1	7.3		7.3	6.8		7.2	6.8		110
115	9.9	8.2	6.8	9.1	7.7	6.6	8	7.2		7.2	6.8		7.1	6.7		115
120	9.7	8	6.7	8.9	7.6	6.5	7.9	7.1	6.2	7.2	6.7		7	6.6		120
125	9.6	7.9	6.6	8.8	7.5	6.4	7.8	7	6.2	7.1	6.6		7	6.5		125
130	9.4	7.7	6.5	8.7	7.3	6.3	7.7	6.9	6.1	7	6.5	5.9	6.9	6.5	5.8	130
135	9.2	7.6	6.4	8.6	7.2	6.3	7.7	6.8	6.1	7	6.4	5.9	6.9	6.4	5.8	135
140	9	7.4	6.4	8.4	7.1	6.2	7.6	6.7	6	6.9	6.4	5.8	6.8	6.3	5.8	140
145	8.8	7.3	6.3	8.3	7	6.2	7.5	6.6	6	6.8	6.3	5.8	6.7	6.2	5.8	145
150	8.7	7.1	6.3	8.1	6.9	6.1	7.4	6.6	5.9	6.7	6.2	5.7	6.6	6.2	5.7	150
155	8.5	7	6.2	8	6.8	6.1	7.3	6.5	5.9	6.6	6.2	5.7	6.5	6.1	5.7	155
160	8.3	6.9	6.2	7.9	6.7	6	7.2	6.4	5.9	6.5	6.1	5.7	6.4	6.1	5.7	160
165	8.1	6.8	6.1	7.7	6.6	6	7.1	6.3	5.8	6.4	6	5.7	6.4	6	5.6	165
170	7.9	6.7	6.1	7.6	6.5	5.9	7	6.3	5.8	6.3	5.9	5.6	6.2	5.9	5.6	170
175	7.8	6.7	6	7.4	6.4	5.9	6.9	6.2	5.8	6.2	5.8	5.6	6.1	5.8	5.6	175
180	7.6	6.6	6	7.3	6.4	5.9	6.8	6.1	5.7	6	5.7	5.6	6	5.7	5.6	180
185	7.4	6.5	6	7.2	6.3	5.9	6.7	6.1	5.7	5.8	5.6	5.5	5.8	5.6	5.5	185
190	7.3	6.4	5.9	7.1	6.2	5.8	6.6	6	5.7	5.7	5.5	5.4	5.6	5.5	5.4	190
195	7.1	6.3	5.9	7	6.2	5.8	6.5	6	5.7	5.5	5.4	5.3	5.5	5.4	5.3	195
200	7	6.3	5.9	6.8	6.1	5.8	6.3	5.9	5.7	5.3	5.3	5.3	5.3	5.3	5.2	200
205	6.9	6.2	5.9	6.7	6.1	5.8	6.2	5.8	5.7	5.1	5.2	5.2	5.1	5.1	5.2	205
210	6.8	6.2	5.9	6.6	6	5.8	6.1	5.7	5.7	5	5	5.1	4.9	5	5.1	210
215	6.7	6.1	5.9	6.5	6	5.8	5.9	5.6	5.6	4.8	4.9	5	4.8	4.9	5	215
220	6.6	6	5.9	6.5	5.9	5.8	5.8	5.5	5.6	4.6	4.8	4.9	4.6	4.7	4.9	220
225	6.5	6	5.9	6.4	5.9	5.8	5.7	5.5	5.5	4.5	4.6	4.8	4.4	4.6	4.8	225
230	6.4	6	5.9	6.3	5.9	5.8	5.5	5.4	5.4	4.3	4.5	4.7	4.3	4.5	4.7	230
235	6.4	6	5.9	6.2	5.8	5.8	5.4	5.3	5.4	4.1	4.3	4.6	4.1	4.3	4.6	235
240	6.3	5.9	5.9	6	5.8	5.8	5.2	5.2	5.3	4	4.2	4.5	3.9	4.1	4.4	240
245	6.1	5.9	5.9	5.8	5.7	5.8	5.1	5.1	5.2	3.8	4	4.3	3.7	4	4.3	245
250	5.8	5.9	5.9	5.6	5.7	5.8	4.9	5	5.1	3.7	3.9	4.1	3.4	3.8	4.1	250
255	5.4	5.8	5.9	5.3	5.6	5.8	4.7	4.9	5	3.5	3.7	4	3.2	3.6	4	255
260	5.3	5.6	5.8	4.9	5.5	5.7	4.5	4.7	4.9	3.3	3.6	3.8	2.9	3.4	3.8	260
265	5.1	5.2	5.3	4.4	5.2	5.4	4.3	4.6	4.8	3.2	3.4	3.6	2.6	3.2	3.5	265
270	4.9	5.1		4.2	4.8	5	4.1	4.5	4.6	3	3.3	3.5	2.4	3	3.2	270
275	4.7	4.9		4.1	4.2	4.4	3.7	4.3	4.4	2.7	3.1	3.3		2.7	2.9	275
280	3.6	4.7		3.9	4.1	4.2	3.2	4.1	4.2		2.9	3.1		2.4	2.5	280
285		3.5		3.8	4		2.8	3.7	3.8		2.8	3			2.2	285
290				3.6	3.8		2.1	3.1	3.3			2.7				290
295					3.6			2.6	2.7							295

t_240_002_56501_00_000

Lifting capacities Forces de levage

TNZK

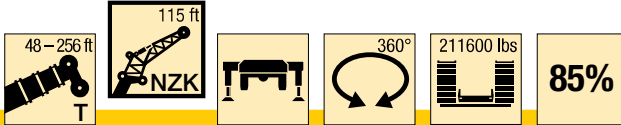

ft	48 ft			144 ft			160 ft			176 ft			192 ft			ft
	115 ft			115 ft			115 ft			115 ft			115 ft			
	0°	20°	40°	0°	20°	40°	0°	20°	40°	0°	20°	40°	0°	20°	40°	
19	9.1															19
20	9.1															20
22	9.2															22
24	10.1															24
26	10.8															26
28	11.2															28
30	11.1															30
32	10.9															32
34	10.8															34
36	10.6			9.3												36
38	10.5			9.7												38
40	10.3			10			9.1									40
45	9.9			10.7			9.8			8.7						45
50	9.5			11			10.3			9.2			7.8			50
55	9			10.9			10.4			9.6			8.3			55
60	8.6	7.4		10.7			10.2			9.7			8.7			60
65	8.2	7		10.4			10			9.5			8.8			65
70	7.7	6.6		10.2			9.8			9.4			8.7			70
75	7.2	6.3		9.9			9.6			9.2			8.6			75
80	6.8	6		9.7	7.3		9.4	7.2		9			8.4			80
85	6.5	5.7		9.4	7.1		9.2	7		8.8	6.9		8.2			85
90	6.1	5.5	4.8	9.1	6.9		8.9	6.8		8.6	6.7		8.1	6.4		90
95	5.8	5.2	4.6	8.8	6.6		8.7	6.6		8.4	6.5		7.9	6.3		95
100	5.6	5	4.5	8.6	6.4		8.4	6.4		8.2	6.3		7.7	6.2		100
105	5.3	4.8	4.3	8.3	6.2	4.6	8.2	6.2		7.9	6.1		7.5	6		105
110	5.1	4.6	4.2	8	6.1	4.5	7.9	6	4.5	7.7	6		7.4	5.8		110
115	4.9	4.4	4.1	7.7	5.9	4.5	7.7	5.9	4.5	7.5	5.8	4.4	7.2	5.7		115
120	4.7	4.3	3.9	7.4	5.7	4.4	7.4	5.7	4.4	7.3	5.7	4.3	7	5.6	4.3	120
125	4.5	4.1	3.9	7.1	5.6	4.4	7.2	5.6	4.3	7.1	5.5	4.3	6.8	5.4	4.2	125
130	4.3	4	3.8	6.9	5.4	4.3	6.9	5.4	4.3	6.9	5.4	4.2	6.7	5.3	4.2	130
135	4.2	3.9	3.8	6.6	5.3	4.2	6.7	5.3	4.2	6.7	5.3	4.2	6.5	5.2	4.1	135
140	4	3.8	3.8	6.4	5.1	4.2	6.5	5.2	4.2	6.5	5.1	4.2	6.3	5.1	4.1	140
145	3.9	3.8	3.8	6.2	5	4.2	6.3	5	4.2	6.3	5	4.1	6.2	5	4	145
150	3.8	3.8		6	4.9	4.1	6.1	4.9	4.1	6.1	4.9	4.1	6	4.8	4	150
155	3.7	3.8		5.8	4.8	4.1	5.9	4.8	4	6	4.8	4	5.9	4.7	4	155
160				5.7	4.6	4	5.8	4.7	4	5.8	4.7	4	5.7	4.6	3.9	160
165				5.5	4.6	3.9	5.6	4.6	3.9	5.7	4.6	3.9	5.6	4.6	3.9	165
170				5.3	4.5	3.9	5.5	4.5	3.9	5.5	4.5	3.9	5.5	4.5	3.8	170
175				5.2	4.4	3.9	5.3	4.4	3.8	5.3	4.4	3.8	5.3	4.4	3.8	175
180				5	4.3	3.8	5.2	4.3	3.8	5.2	4.3	3.8	5.2	4.3	3.7	180
185				4.9	4.2	3.8	5	4.2	3.8	5.1	4.3	3.7	5.1	4.2	3.7	185
190				4.8	4.1	3.8	4.9	4.2	3.8	5	4.2	3.7	4.9	4.2	3.7	190
195				4.7	4	3.8	4.8	4.1	3.7	4.9	4.1	3.7	4.8	4.1	3.6	195
200				4.5	4	3.8	4.7	4	3.7	4.7	4	3.7	4.7	4	3.6	200
205				4.4	3.9	3.8	4.6	4	3.7	4.6	4	3.6	4.6	4	3.6	205
210				4.3	3.9	3.8	4.4	3.9	3.7	4.5	3.9	3.6	4.5	3.9	3.6	210
215				4.2	3.8	3.8	4.3	3.9	3.7	4.4	3.9	3.6	4.4	3.8	3.6	215
220				4.1	3.8	3.8	4.2	3.8	3.7	4.3	3.8	3.6	4.3	3.8	3.6	220
225				4	3.8	3.8	4.2	3.8	3.7	4.3	3.8	3.6	4.2	3.8	3.6	225
230				4	3.8	3.8	4.1	3.7	3.7	4.2	3.7	3.6	4.2	3.7	3.6	230
235				3.9	3.8		4	3.7	3.7	4.1	3.7	3.6	4.1	3.7	3.6	235
240				3.8	3.8		3.9	3.7	3.7	4	3.7	3.6	4	3.6	3.6	240
245				3.8	3.8		3.9	3.7		3.9	3.7	3.6	4	3.6	3.6	245
250							3.8	3.7		3.9	3.6	3.6	3.9	3.6	3.6	250
255							3.7	3.7		3.8	3.6	3.6	3.8	3.6	3.6	255
260							3.7	3.7		3.7	3.6		3.8	3.6	3.6	260
265										3.7	3.6		3.7	3.6	3.6	265
270										3.7	3.6		3.7	3.6	3.6	270
275										2.5	3.6		3.6	3.6		275
280													3.6	3.6		280
285													3.3	3.6		285
290													2.4	3.4		290
295														2.5		295

t_240_002_56601_00_000

Lifting capacities Forces de levage

TNZK

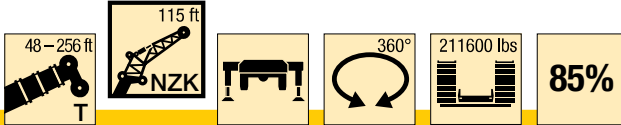

ft	208 ft			224 ft			240 ft			253 ft			256 ft			ft
	115 ft			115 ft			115 ft			115 ft			115 ft			
	0°	20°	40°	0°	20°	40°	0°	20°	40°	0°	20°	40°	0°	20°	40°	
55	6.7															55
60	7.1			5.6												60
65	7.5			5.9			4.6									65
70	7.6			6.3			4.8									70
75	7.7			6.5			5.1			4			3.8			75
80	7.6			6.6			5.3			4			3.8			80
85	7.5			6.6			5.4			4.1			3.8			85
90	7.3			6.6			5.5			4.2			3.8			90
95	7.2			6.6			5.6			4.3			3.8			95
100	7.1	5.9		6.5			5.6			4.3			3.9			100
105	7	5.8		6.4	5.4		5.6			4.3			3.9			105
110	6.8	5.6		6.3	5.3		5.6			4.3			3.9			110
115	6.7	5.5		6.2	5.2		5.5	4.7		4.3			3.9			115
120	6.6	5.4		6.1	5.1		5.5	4.7		4.4	4.2		3.9	4.1		120
125	6.5	5.3	4.1	6	5		5.4	4.7		4.4	4.2		3.9	4.1		125
130	6.3	5.1	4	5.9	4.9		5.3	4.6		4.4	4.2		3.9	4.1		130
135	6.2	5	4	5.8	4.8	3.8	5.3	4.5		4.4	4.2		3.9	4.1		135
140	6.1	4.9	4	5.6	4.7	3.8	5.2	4.4	3.6	4.4	4.1		3.9	4		140
145	5.9	4.8	3.9	5.5	4.6	3.8	5.1	4.4	3.6	4.3	4.1		3.9	4		145
150	5.8	4.7	3.9	5.4	4.5	3.8	5	4.3	3.6	4.3	4	3.4	3.9	4	3.3	150
155	5.7	4.6	3.9	5.3	4.4	3.7	4.9	4.2	3.6	4.2	4	3.4	3.9	4	3.3	155
160	5.5	4.5	3.8	5.2	4.4	3.7	4.8	4.1	3.5	4.2	3.9	3.4	3.9	3.9	3.3	160
165	5.4	4.4	3.8	5.1	4.3	3.7	4.8	4.1	3.5	4.2	3.9	3.3	3.9	3.9	3.3	165
170	5.3	4.4	3.8	5	4.2	3.6	4.7	4	3.5	4.1	3.8	3.3	3.8	3.8	3.3	170
175	5.2	4.3	3.7	4.9	4.2	3.6	4.6	4	3.5	4.1	3.8	3.3	3.8	3.8	3.3	175
180	5	4.2	3.7	4.8	4.1	3.6	4.5	3.9	3.5	4	3.7	3.3	3.7	3.7	3.3	180
185	4.9	4.1	3.6	4.7	4	3.6	4.5	3.8	3.4	4	3.7	3.3	3.7	3.7	3.3	185
190	4.8	4.1	3.6	4.7	3.9	3.5	4.4	3.8	3.4	3.9	3.6	3.3	3.7	3.6	3.3	190
195	4.7	4	3.6	4.6	3.9	3.5	4.3	3.7	3.4	3.9	3.6	3.3	3.6	3.6	3.3	195
200	4.6	4	3.5	4.5	3.9	3.5	4.2	3.7	3.4	3.8	3.5	3.3	3.6	3.5	3.3	200
205	4.5	3.9	3.5	4.4	3.8	3.5	4.2	3.6	3.4	3.7	3.5	3.3	3.6	3.5	3.2	205
210	4.4	3.8	3.5	4.3	3.8	3.4	4.1	3.6	3.4	3.7	3.5	3.3	3.5	3.4	3.2	210
215	4.4	3.8	3.5	4.3	3.7	3.4	4	3.6	3.3	3.6	3.4	3.2	3.5	3.4	3.2	215
220	4.3	3.7	3.5	4.2	3.7	3.4	4	3.5	3.3	3.5	3.4	3.2	3.5	3.4	3.2	220
225	4.2	3.7	3.5	4.1	3.6	3.4	3.9	3.5	3.3	3.4	3.3	3.2	3.3	3.4	3.2	225
230	4.1	3.7	3.5	4	3.6	3.4	3.9	3.5	3.3	3.2	3.3	3.2	3.2	3.3	3.2	230
235	4.1	3.6	3.5	4	3.5	3.4	3.8	3.4	3.3	3.1	3.2	3.2	3.1	3.2	3.2	235
240	4	3.6	3.5	3.9	3.5	3.4	3.8	3.4	3.3	2.9	3.1	3.2	2.9	3.1	3.2	240
245	3.9	3.6	3.5	3.9	3.5	3.4	3.7	3.4	3.3	2.8	3	3.2	2.8	3	3.2	245
250	3.9	3.5	3.5	3.8	3.4	3.4	3.6	3.4	3.3	2.6	2.9	3.1	2.6	2.9	3.1	250
255	3.8	3.5	3.5	3.7	3.4	3.4	3.5	3.3	3.3	2.5	2.8	3.1	2.5	2.8	3	255
260	3.8	3.5	3.5	3.7	3.4	3.4	3.5	3.3	3.3	2.3	2.7	3	2.3	2.6	3	260
265	3.7	3.5	3.5	3.6	3.4	3.4	3.4	3.3	3.3	2.2	2.5	2.8		2.5	2.8	265
270	3.7	3.5	3.5	3.5	3.4	3.4	3.3	3.3	3.3		2.4	2.7		2.4	2.7	270
275	3.6	3.5	3.5	3.4	3.4	3.4	3.2	3.2	3.3		2.2	2.5		2.2	2.5	275
280	3.5	3.5	3.5	3.2	3.3	3.4	3	3.1	3.3			2.4			2.4	280
285	3.5	3.5		2.9	3.3	3.4		3.1	3.3			2.2				285
290	3.5	3.5		2.8	3.2	3.4		3	3.3							290
295	3.3	3.5		2.6	2.8	3.2		2.8	3.1							295
300	2.2	3.4		2.5	2.7				2.7							300
305		2.6			2.6											305
310					2.4											310

t_240_002_56601_00_000

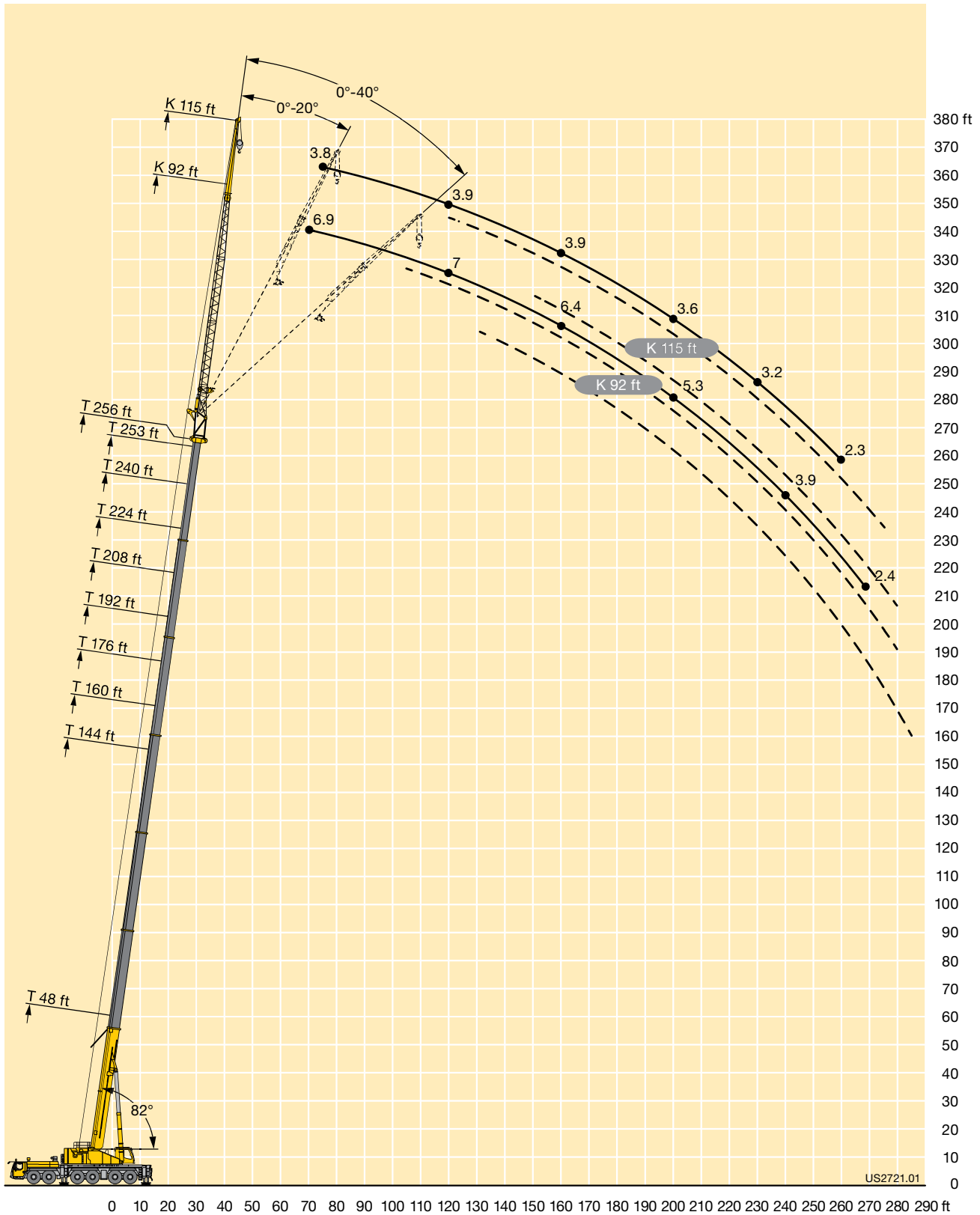

Lifting capacities Forces de levage

TF

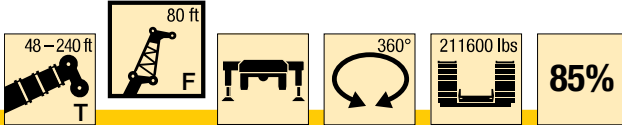

ft	48 + 6.6 ft*			144 + 6.6 ft*			160 + 6.6 ft*			176 + 6.6 ft*			192 + 6.6 ft*			208 + 6.6 ft*			224 + 6.6 ft*			240 + 6.6 ft*			ft
	80 ft			80 ft			80 ft			80 ft			80 ft			80 ft			80 ft						
	0°	20°	40°	0°	20°	40°	0°	20°	40°	0°	20°	40°	0°	20°	40°	0°	20°	40°	0°	20°	40°	0°	20°	40°	
18	31.8																							18	
19	31.8																							19	
20	31.5																							20	
22	30.7																							22	
24	29.8																							24	
26	29																							26	
28	28.2																							28	
30	27.4																							30	
32	26.6																							32	
34	25.9																							34	
36	25.1																							36	
38	24.4																							38	
40	23.6																							40	
45	21.9																							45	
50	20.3	18.2																						50	
55	18.8	17.2																						55	
60	17.5	16.3																						60	
65	16.2	15.5																						65	
70	15.1	14.7	13.1																					70	
75	14	13.9	12.6																					75	
80	13.1	13	12.1																					80	
85	12.3	12.3	11.7																					85	
90	11.5	11.6	11.2																					90	
95	10.9	11	10.8																					95	
100	10.3	10.4	10.3																					100	
105	9.7	9.9	9.9																					105	
110	9.2	9.4	9.5																					110	
115	8.8	9	9.2																					115	
120	8.4	8.6	9.1																					120	
125	8.2	8.4																						125	
130																								130	
135																								135	
140																								140	
145																								145	
150																								150	
155																								155	
160																								160	
165																								165	
170																								170	
175																								175	
180																								180	
185																								185	
190																								190	
195																								195	
200																								200	
205																								205	
210																								210	
215																								215	
220																								220	
225																								225	
230																								230	
235																								235	
240																								240	
245																								245	
250																								250	
255																								255	
260																								260	
265																								265	
270																								270	
275																								275	
280																								280	
285																								285	
290																								290	

* adapter · pièce d'adaptateur

t_240_003_50401_00_000 / 52401_00_000 / 54401_00_000

Lifting capacities Forces de levage

TF

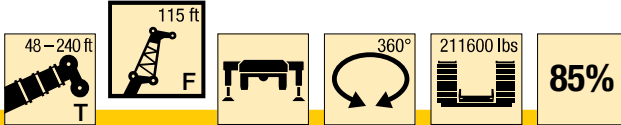

ft	48 + 6.6 ft*			144 + 6.6 ft*			160 + 6.6 ft*			176 + 6.6 ft*			192 + 6.6 ft*			208 + 6.6 ft*			224 + 6.6 ft*			240 + 6.6 ft*			ft
	115 ft			115 ft			115 ft			115 ft			115 ft			115 ft			115 ft						
	0°	20°	40°	0°	20°	40°	0°	20°	40°	0°	20°	40°	0°	20°	40°	0°	20°	40°	0°	20°	40°	0°	20°	40°	
24	19.6																							24	
26	19.5																							26	
28	19.2																							28	
30	18.7																							30	
32	18.2																							32	
34	17.7																							34	
36	17.2																							36	
38	16.8																							38	
40	16.4																							40	
45	15.4																							45	
50	14.5																							50	
55	13.5																							55	
60	12.7																							60	
65	11.9	10																						65	
70	11.1	9.5																						70	
75	10.5	9																						75	
80	9.8	8.5																						80	
85	9.3	8																						85	
90	8.8	7.6																						90	
95	8.3	7.2	6.2																					95	
100	7.8	6.8	6																					100	
105	7.4	6.5	5.8																					105	
110	7	6.3	5.6																					110	
115	6.6	6	5.4																					115	
120	6.3	5.8	5.2																					120	
125	6	5.6	5.1																					125	
130	5.7	5.4	5																					130	
135	5.5	5.3	4.9																					135	
140	5.2	5.1	4.9																					140	
145	5	5	4.8																					145	
150	4.8	4.9	4.8																					150	
155	4.7	4.9	4.8																					155	
160	4.6	4.8																						160	
165																								165	
170																								170	
175																								175	
180																								180	
185																								185	
190																								190	
195																								195	
200																								200	
205																								205	
210																								210	
215																								215	
220																								220	
225																								225	
230																								230	
235																								235	
240																								240	
245																								245	
250																								250	
255																								255	
260																								260	
265																								265	
270																								270	
275																								275	
280																								280	
285																								285	
290																								290	
295																								295	
300																								300	
305																								305	

* adapter · pièce d'adaptateur

t_240_003_50701_00_000 / 52701_00_000 / 54701_00_000

Lifting capacities Forces de levage

TF

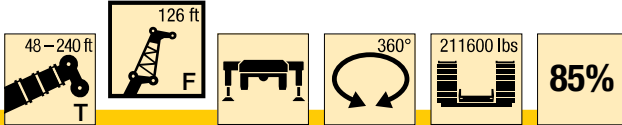

ft	48 + 6.6 ft*			144 + 6.6 ft*			160 + 6.6 ft*			176 + 6.6 ft*			192 + 6.6 ft*			208 + 6.6 ft*			224 + 6.6 ft*			240 + 6.6 ft*			ft
	126 ft			126 ft			126 ft			126 ft			126 ft			126 ft			126 ft						
	0°	20°	40°	0°	20°	40°	0°	20°	40°	0°	20°	40°	0°	20°	40°	0°	20°	40°	0°	20°	40°	0°	20°	40°	
28	16.7																							28	
30	16.4																								30
32	16																								32
34	15.6																								34
36	15.2																								36
38	14.8																								38
40	14.5																								40
45	13.6																								45
50	12.8																								50
55	12																								55
60	11.3																								60
65	10.6																								65
70	9.9	8.1																							70
75	9.2	7.8																							75
80	8.7	7.3																							80
85	8.1	7																							85
90	7.6	6.6																							90
95	7.3	6.3																							95
100	6.9	6																							100
105	6.5	5.7	4.9																						105
110	6.2	5.4	4.7																						110
115	5.9	5.2	4.5																						115
120	5.6	5	4.4																						120
125	5.3	4.8	4.2																						125
130	5	4.6	4.1																						130
135	4.8	4.4	4																						135
140	4.6	4.2	3.9																						140
145	4.4	4.1	3.8																						145
150	4.2	4	3.7																						150
155	4	3.9	3.7																						155
160	3.8	3.8	3.7																						160
165	3.7	3.8	3.7																						165
170	3.6	3.8																							170
175																									175
180																									180
185																									185
190																									190
195																									195
200																									200
205																									205
210																									210
215																									215
220																									220
225																									225
230																									230
235																									235
240																									240
245																									245
250																									250
255																									255
260																									260
265																									265
270																									270
275																									275
280																									280
285																									285
290																									290
295																									295
300																									300
305																									305

* adapter · pièce d'adaptateur

t_240_003_50801_00_000 / 52801_00_000 / 54801_00_000

Lifting heights Hauteurs de levage

TF

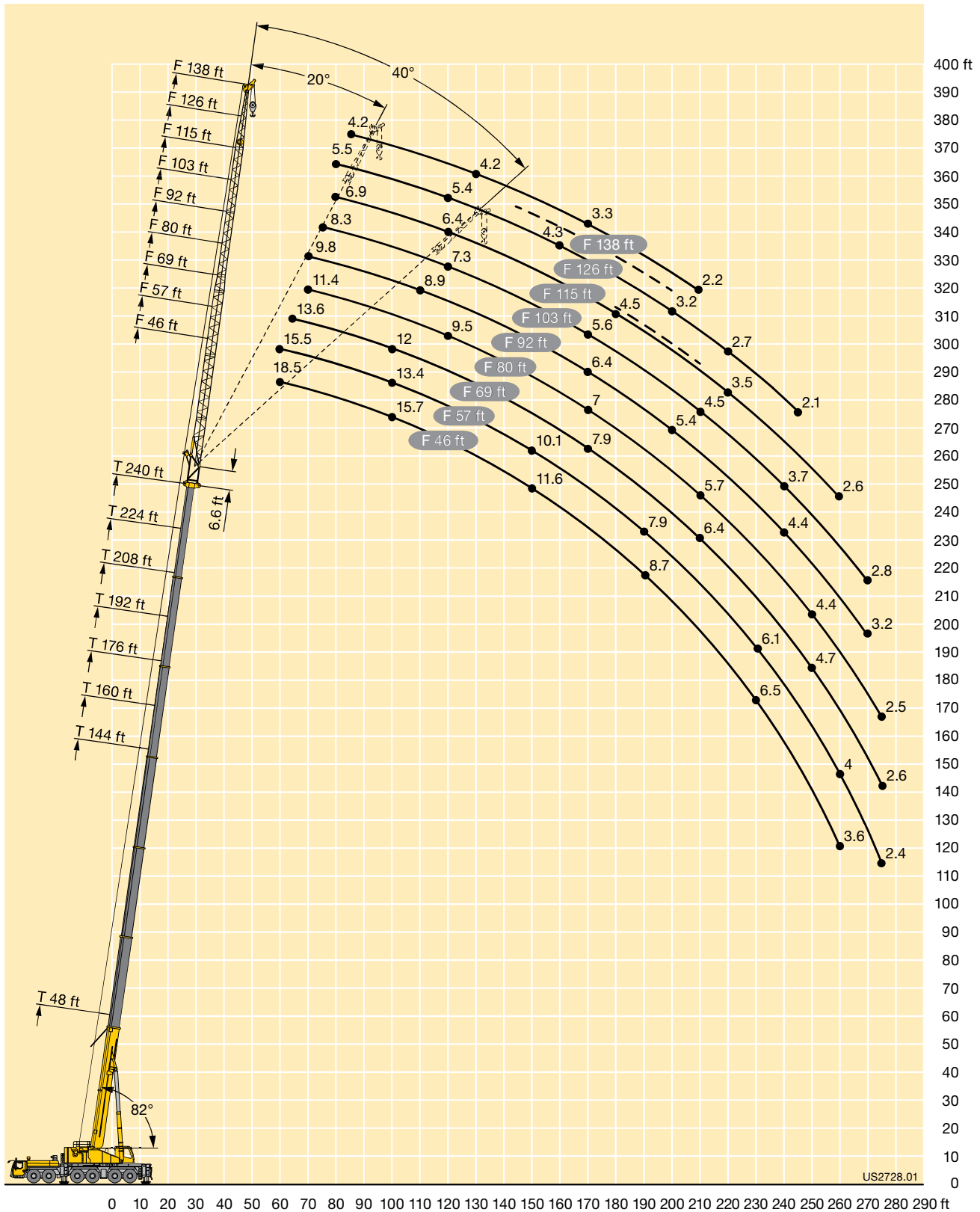

Lifting capacities Forces de levage

TN

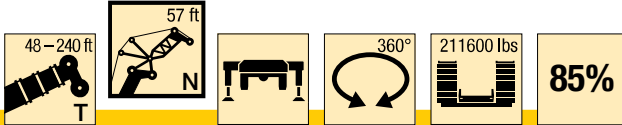

ft	48 + 11.5 ft*			64 + 11.5 ft*			80 + 11.5 ft*			96 + 11.5 ft*			112 + 11.5 ft*			ft
	57 ft			57 ft			57 ft			57 ft			57 ft			
	82°	75°	68°	82°	75°	68°	82°	75°	68°	82°	75°	68°	82°	75°	68°	
26	110.7															26
28	110.8															28
30	110.7			103.2												30
32	110.3			103.9			93.9									32
34	109.3			104.4			94.2			82.8						34
36	108			104.8			94.4			82.8						36
38	107			104.9			94.4			82.7			70.8			38
40	106.1	105.1		104.6			94.4			82.6			70.7			40
45	103.5	98.5		102.5	100.6		94.4			82.6			70.7			45
50	95.6	93.2		100.2	97.6		94.4	91.4		82.6			70.7			50
55	83.9	89.5	86.2	90.4	94.6		93	91.1		82.6	79.8		70.7			55
60	65.5	86.5	81.6	79	91.7	89.2	85.4	89.9		82.6	79.9		70.7	68.2		60
65		78.8	78.3		88	84.7	72.9	88.8		80.5	80.4		70.7	68.2		65
70			77.2		78.3	81.6		86.3	81.7		80.8		70.7	68.2		70
75			72.9					78	75.9		78.5	73.1		68.2		75
80						73.7			70.7		73.2	68.2		68.2		80
85									66			63.7		65.9	60.1	85
90												59.7			56.4	90
95															53	95
100															49.9	100

* adapter · pièce d'adaptateur

t_240_004_50101_00_000

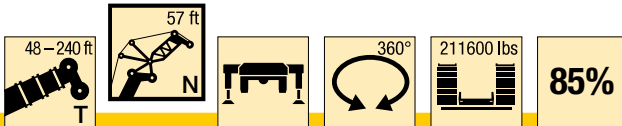

ft	128 + 11.5 ft*			144 + 11.5 ft*			160 + 11.5 ft*			176 + 11.5 ft*		192 + 11.5 ft*		208 + 11.5 ft*	224 + 11.5 ft*	240 + 11.5 ft*	ft
	57 ft			57 ft			57 ft			57 ft		57 ft		57 ft	57 ft	57 ft	
	82°	75°	68°	82°	75°	68°	82°	75°	68°	82°	75°	82°	75°	82°	82°	82°	
40	60.7																40
45	60.6			49.7													45
50	60.5			49.6			39.3										50
55	60.5			49.6			39.2			32.2		25					55
60	60.5			49.6			39			32.1		24.9		18.7			60
65	60.5	58.4		49.6			38.9			32		24.9		18.7	12.7	7.7	65
70	60.5	58.5		49.6			38.9			31.9		24.8		18.6	12.6	7.6	70
75		58.8		49.6	48		38.9			31.9		24.8		18.5	12.4	7.4	75
80		59.1			48.1			37.8				24.8		18.4	12.3	7.3	80
85		59.1			48			37.6			30.3				12.2	7.2	85
90		59			47			37.4			30.2						90
95			54.3					37.3			30		23.2				95
100			48.2								29.9		23.1				100
105			45.5										22.9				105
110						40.6											110
115						39.2											115
						37.9											
									33								
									31.8								
									30.9								

* adapter · pièce d'adaptateur

t_240_004_50101_00_000

Lifting capacities Forces de levage

TN

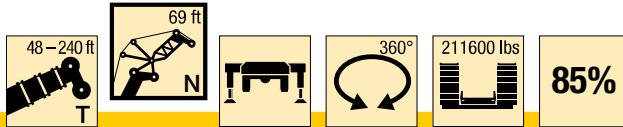

ft	48 + 11.5 ft*			64 + 11.5 ft*			80 + 11.5 ft*			96 + 11.5 ft*			112 + 11.5 ft*			ft
	69 ft			69 ft			69 ft			69 ft			69 ft			
	82°	75°	68°	82°	75°	68°	82°	75°	68°	82°	75°	68°	82°	75°	68°	
30	97.7															30
32	97.6			91.4												32
34	97.1			91.5												34
36	96.2			91.6			83.4									36
38	95.1			91.4			83.2			73.4						38
40	94			91.1			83.1			73.4						40
45	91.5	90.3		89.5			82.8			73.1			63.4			45
50	89.4	86.9		87.9	86.8		82.6			73			63.3			50
55	87.9	83		86.8	84.4		82.3	80.5		73			63.3			55
60	83.7	79.6	77.8	85.6	82.5		81.9	79.2		73	70.9		63.3			60
65	73.7	77.3	73.7	81.2	80.8	79.3	81.9	77.7		73	70.8		63.3	61.3		65
70	57.8	75.9	70.6	69.3	79.6	76.3	77	76.6		73	70.5		63.3	61.2		70
75		70.6	68.3	51.8	79.2	73.6	64.4	76	74.2	73	69.9		63.3	61.2		75
80			67.7		71.4	71.4		74.8	70.3		69.7	67.6	63.3	61.2		80
85			65.8			68.6		69.9	65.7		68.3	63.5		61.2		85
90						64.4			61.6		64.2	59.6		60.8	55.9	90
95									57.9			56		58	52.6	95
100												52.9			49.7	100
105															46.9	105
110															44.4	110

* adapter · pièce d'adaptateur

t_240_004_50201_00_000

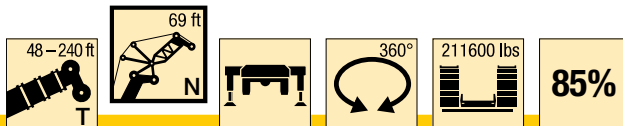

ft	128 + 11.5 ft*			144 + 11.5 ft*			160 + 11.5 ft*			176 + 11.5 ft*			192 + 11.5 ft*			208 + 11.5 ft*		224 + 11.5 ft*		240 + 11.5 ft*		ft
	69 ft			69 ft			69 ft			69 ft			69 ft			69 ft		69 ft		69 ft		
	82°	75°	68°	82°	75°	68°	82°	75°	68°	82°	75°	68°	82°	75°	68°	82°	75°	82°	75°	82°	75°	
45	54.5																					45
50	54.5			44.9			34.6															50
55	54.5			44.9			34.5			28.3												55
60	54.5			44.9			34.2			28.2			21.5									60
65	54.5			44.9			34			28			21.4		15.9							65
70	54.5	52.7		44.9			33.9			27.9			21.3		15.7		10.3		5.9			70
75	54.5	52.8		44.9			33.8			27.8			21.3		15.6		10.1		5.8			75
80	54.5	52.9		44.9	43.3		33.8			27.8			21.3		15.4		10		5.7			80
85		53.1		44.9	43		33.8	32.9		27.7			21.3		15.3		9.9		5.6			85
90		53.3			42.9			32.7		27.7	26.8		21.3		15.3		9.8		5.5			90
95		53.6	50.5		42.7			32.6		26.7					15.3		9.8		5.5			95
100		52.9	47.7		42			32.5		26.6							9.8		5.5			100
105			45.1		41.2	37.5		32.5		26.5					20.2							105
110			42.7			36.3				26.5					20.1			14.1				110
115			40.5			35.2									20			13.9				115
120						34.2									19.9			13.8		8.7		120
125																		13.8		8.6	4.5	125
130																				8.5	4.4	130
135																					4.4	135
140																						140

* adapter · pièce d'adaptateur

t_240_004_50201_00_000

Lifting capacities Forces de levage

TN

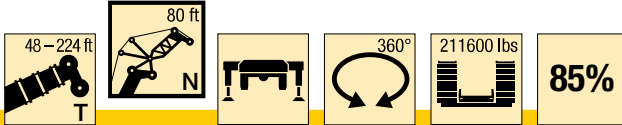

ft	48 + 11.5 ft*			64 + 11.5 ft*			80 + 11.5 ft*			96 + 11.5 ft*			112 + 11.5 ft*			ft
	80 ft			80 ft			80 ft			80 ft			80 ft			
	82°	75°	68°	82°	75°	68°	82°	75°	68°	82°	75°	68°	82°	75°	68°	
34	85.6															34
36	85.3			80.1												36
38	84.3			79.9												38
40	83.4			79.7			72.9									40
45	81.2			78.9			72.6			64.6			56.3			45
50	79.3	78.7		77.5			72.4			64.4			56.2			50
55	77.5	76.4		76.2	75.4		72			64.4			56.1			55
60	76.2	73.7		75	73.7		71.1	70.4		64.4			56.1			60
65	74.5	71.2	70.1	74.3	71.9		70.5	68.9		64.4	62.5		56.1			65
70	70.6	68.8	67	72.6	70.6		70.3	67.6		64.4	62.4		56.1	54.4		70
75	62.6	67.1	64	68.3	69.5	68.5	70.3	66.7		64.4	61.9		56.1	54.3		75
80	51.6	65.8	61.7	59.7	68.8	66.2	66.2	66	65.1	64.4	61.2		56.1	54.3		80
85		61	59.9	48.5	67.9	64.4	57.4	65.6	63.7	64.3	60.7		56.1	54.3		85
90		49.3	59.4		61.5	62.8		65	61.5	54.4	60.6	58.7	56.1	54.3		90
95			57.7		50.8	60.4		61.7	57.9		60.1	55.7		54.3	52.1	95
100						57			54.6		56.8	52.6		53.9	49.3	100
105									51.6			49.7		51.5	46.6	105
110									48.9			47.1			44.2	110
115												44.7			41.9	115
120															39.9	120

* adapter · pièce d'adaptateur

t_240_004_50301_00_000

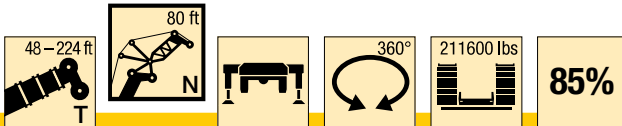

ft	128 + 11.5 ft*			144 + 11.5 ft*			160 + 11.5 ft*			176 + 11.5 ft*			192 + 11.5 ft*			208 + 11.5 ft*			224 + 11.5 ft*		ft
	80 ft			80 ft			80 ft			80 ft			80 ft			80 ft			80 ft		
	82°	75°	68°	82°	75°	68°	82°	75°	68°	82°	75°	68°	82°	75°	68°	82°	75°	68°	82°	75°	
50	48.5																				50
55	48.5			40.4			30.4														55
60	48.4			40.4			30.2			24.3											60
65	48.4			40.3			30.1			24.3			19								65
70	48.4			40.3			29.9			24.2			19		13.5				8.4		70
75	48.4	46.9		40.3			29.7			24.1			18.9		13.3				8.3		75
80	48.4	46.9		40.3			29.6			24			18.9		13.2				8.1		80
85	48.4	47		40.3	38.7		29.6			23.9			18.9		13.1				8		85
90	48.4	47		40.3	38.5		29.6	28.8		23.9			18.9		13				8		90
95	48.4	47		40.3	38.4		29.6	28.7		23.9	23.2		18.9		12.9				7.9		95
100		47			38.4		29.6	28.6		23.9	23.2		18.9		12.9				7.9		100
105		47	45		38.2			28.6			23.1			17.7	12.9				7.9		105
110		47	42.6		37.8	34.5		28.6			23.1			17.6			11.7				110
115			40.5		37.2	33.8		28.6			23.1			17.5			11.7				115
120			38.5			32.8		28.6	27.1		23.1			17.4			11.6			6.8	120
125			36.7			31.9			26.3		23.1			17.4			11.5			6.7	125
130						31			25.6			20.5					11.5			6.7	130
135									25			19.9								6.6	135
140									24.4			19.4			14.8						140
145												18.9			14.4						145
150															14						150
155																				10.3	155

* adapter · pièce d'adaptateur

t_240_004_50301_00_000

Lifting capacities Forces de levage

TN

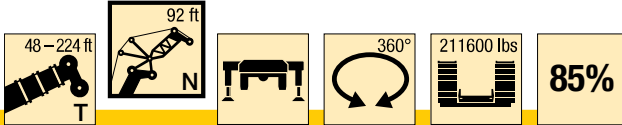

ft	48 + 11.5 ft*			64 + 11.5 ft*			80 + 11.5 ft*			96 + 11.5 ft*			112 + 11.5 ft*			ft
	92 ft			92 ft			92 ft			92 ft			92 ft			
	82°	75°	68°	82°	75°	68°	82°	75°	68°	82°	75°	68°	82°	75°	68°	
38	74.4															38
40	73.8			70.3												40
45	72			69.5			64.4									45
50	70.3			68.5			64				57.4			50.1		50
55	68.8	68.4		67.3			63.4				57.2			50		55
60	67.4	66.7		66.3	65.8		62.9				56.9			49.9		60
65	66.2	64.9		65.2	64.3		62.2	61.5			56.6			49.7		65
70	65.4	63.3		64.5	63		61.5	60.5			56.3	54.8		49.6		70
75	63.9	61.5	60.6	63.9	61.8		61.2	59.4			56.2	54.8		49.6	47.7	75
80	61.2	60	58.2	62.7	60.8	60.4	61	58.6			56.1	54.4		49.6	48.1	80
85	54.8	58.9	56	59.3	60.1	59	61	57.9	57.4		56.1	53.7		49.6	47.9	85
90	46.6	57.7	54.3	52.7	59.6	57.7	57	57.4	56.4		56	53.3		49.6	47.8	90
95	37.4	53.8	52.9	44.6	59.2	56.4	50.4	57.2	55.3		55.5	53	52.1	49.6	47.7	95
100		45.7	52.5		54.3	55.4	40	56.9	54		48.4	52.8	51.4	49.6	47.7	100
105			51.8		46.9	53.7		54.8	51.3			52.8	49.3		47.7	105
110						51		47.2	48.6			50.6	46.7		47.7	110
115									46.2			47.8	44.4		46.3	115
120									43.9				42.2		44	120
125													40.2			125
130															37.9	130
															36.1	130

* adapter · pièce d'adaptateur

t_240_004_50401_00_000

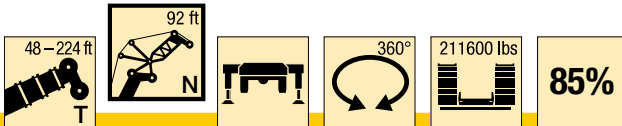

ft	128 + 11.5 ft*			144 + 11.5 ft*			160 + 11.5 ft*			176 + 11.5 ft*			192 + 11.5 ft*			208 + 11.5 ft*			224 + 11.5 ft*		ft
	92 ft			92 ft			92 ft			92 ft			92 ft			92 ft			92 ft		
	82°	75°	68°	82°	75°	68°	82°	75°	68°	82°	75°	68°	82°	75°	68°	82°	75°	68°	82°	75°	
55	43.2			36																	55
60	43.2			36			26.2														60
65	43.2			36			26.1			21.5											65
70	43.1			36			25.9			21.4			16.8			11.3					70
75	43.1			36			25.8			21.3			16.7			11.1			6.5		75
80	43.1	40.8		36			25.7			21.2			16.5			11			6.4		80
85	43.1	41.5		36			25.5			21.2			16.4			10.9			6.3		85
90	43.1	41.8		36	34.4		25.5			21.1			16.3			10.8			6.2		90
95	43.1	41.8		36	34.5		25.5	24.8		21.1			16.2			10.7			6.1		95
100	43.1	41.8		36	34.3		25.5	24.7		21.1	20.4		16.2			10.7			6.1		100
105	43.1	41.8		36	34.3		25.5	24.6		21.1	20.3		16.2			10.6			6		105
110		41.8	39.3		34.3		25.5	24.6		21.1	20.3		16.2	15		10.6			6		110
115		41.8	39.8		34.3			24.6			20.3		16.2	14.9		10.6	9.5		6		115
120		41.8	38.1		34	31		24.6			20.3			14.8			9.5		6		120
125			36.3		33.6	30.4		24.6	23.9		20.3			14.7			9.4			5	125
130			34.6			29.6		24.6	23.7		20.3			14.7			9.3			4.9	130
135			33.1			28.8			23.4		20.3	18.7		14.7			9.3			4.9	135
140			31.6			28.1			22.9			18.2		14.7			9.3			4.9	140
145						27.4			22.3			17.8			13.4					4.9	145
150									21.8			17.3			13.1						150
155												16.9			12.7					8.5	155
160															12.3					8.4	160
165																				8.4	165
170																				8.3	170

* adapter · pièce d'adaptateur

t_240_004_50401_00_000

Lifting capacities Forces de levage

TN

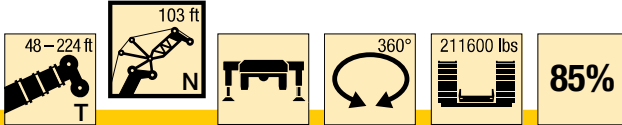

ft	48 + 11.5 ft*			64 + 11.5 ft*			80 + 11.5 ft*			96 + 11.5 ft*			112 + 11.5 ft*			ft
	103 ft			103 ft			103 ft			103 ft			103 ft			
	82°	75°	68°	82°	75°	68°	82°	75°	68°	82°	75°	68°	82°	75°	68°	
45	63.5			60.5												45
50	62.3			59.9				55.7				49.9				50
55	61.1			59.2				55.3				49.6			43.7	55
60	60	59.4		58.5				54.8				49.3			43.5	60
65	59	58.1		57.7	57.1			54.4				49.1			43.4	65
70	58.1	56.9		57	56.1			54	53.1			48.8			43.3	70
75	57.5	55.8		56.5	55.1			53.6	52.7			48.6	47.2		43.2	75
80	56.6	54.8	54.1	56.1	54.3			53.4	51.9			48.5	47.3		43.2	80
85	54.2	53.8	52.4	55.3	53.6	53		53.2	51.3			48.4	47.1		43.1	85
90	50.7	53.2	51	53.8	52.9	52		53.2	50.8			48.4	46.8		43.1	90
95	45.1	52.2	49.7	49.7	52.6	51.1		53.2	50.3	49.5		48.4	46.5		43.1	95
100	38.3	50.2	48.7	43.7	52.3	50.3		48	50.1	48.7		48.3	46.3	44.8	43.1	100
105	31	45.1	48.1	37.3	51.7	49.8		41.9	50	48.1		47.5	46.2	44.9	43.1	105
110		38.4	47.4		46	49.5		34.7	49.5	47.6		41.3	46.2	44.5	42.6	110
115			44.6		39.7	48.2			46.5	46			46.2	44.1	39.1	115
120			36.8			45.9			40.1	43.8			45.6	42.3		120
125						41.1				41.7			42.5	40.3		125
130										39.8				38.5	39.9	130
135														36.7		135
140															34.4	140
145															32.9	145
145															31.4	145

* adapter · pièce d'adaptateur

t_240_004_50501_00_000

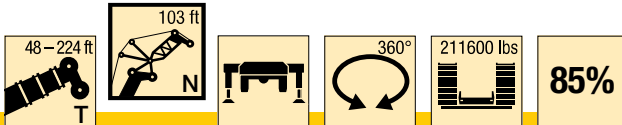

ft	128 + 11.5 ft*			144 + 11.5 ft*			160 + 11.5 ft*			176 + 11.5 ft*			192 + 11.5 ft*			208 + 11.5 ft*			224 + 11.5 ft*			ft
	103 ft			103 ft			103 ft			103 ft			103 ft			103 ft			103 ft			
	82°	75°	68°	82°	75°	68°	82°	75°	68°	82°	75°	68°	82°	75°	68°	82°	75°	68°	82°	75°	68°	
55	37.9																					55
60	37.9			31.7																		60
65	37.8			31.7			23.2															65
70	37.8			31.6			23			19			14.6									70
75	37.7			31.6			22.9			18.9			14.5		9.4							75
80	37.7			31.6			22.8			18.8			14.4		9.3				5			80
85	37.7	35.9		31.6			22.6			18.7			14.2		9.1				4.9			85
90	37.7	36.2		31.6			22.5			18.7			14.1		9				4.8			90
95	37.7	36.5		31.6	30.1		22.4			18.6			14		9				4.7			95
100	37.7	36.5		31.6	30.4		22.4	21.8		18.6			13.9		8.9				4.7			100
105	37.7	36.5		31.6	30.6		22.4	21.7		18.5	18.1		13.8		8.8				4.6			105
110	37.7	36.5		31.6	30.6		22.4	21.7		18.5	17.9		13.8		8.7				4.6			110
115	37.7	36.6	34.1	31.6	30.6		22.4	21.6		18.5	17.8		13.7	12.8	8.7				4.5			115
120		36.7	34.5	31.6	30.5		22.4	21.6		18.5	17.8		13.7	12.7	8.7	7.8			4.5			120
125		36.6	35		30.5	28.5		21.6		17.8			13.7	12.6	8.7	7.8			4.5			125
130		36.6	34.4		30.5	28.1		21.6		17.8			12.5		7.7				4.5	3.6		130
135		36.6	32.9		30.4	27.4		21.6	21	17.8			12.5		7.6				3.6			135
140			31.4			26.7		21.6	20.9	17.8			12.4		7.6				3.6			140
145			30.1			26.1			20.7	17.8	16.8		12.4		7.5				3.5			145
150			28.8			25.6			20.6		16.4		12.4		7.5				3.5			150
155						25			20.2		16			11.6		7.5			3.5			155
160									19.9		15.6			11.6					3.5			160
165											15.2			11.3								165
170														11					6.9			170
175														10.7					7			175
180																			7.1		3.1	180
185																			7.1		3.2	185
185																				3.3		185

* adapter · pièce d'adaptateur

t_240_004_50501_00_000

Lifting capacities Forces de levage

TN

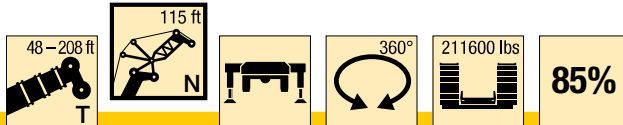

ft	48 + 11.5 ft*			64 + 11.5 ft*			80 + 11.5 ft*			96 + 11.5 ft*			112 + 11.5 ft*			ft
	115 ft			115 ft			115 ft			115 ft			115 ft			
	82°	75°	68°	82°	75°	68°	82°	75°	68°	82°	75°	68°	82°	75°	68°	
45	56.1															45
50	55.4			52.7					48.9							50
55	54.6			52.2					48.6			43.8				55
60	53.7			51.6					48.2			43.6			38.4	60
65	52.8	52.4		51.1					47.8			43.4			38.4	65
70	52	51.4		50.6	50				47.5			43.1			38.3	70
75	51.2	50.3		50	49.3				47.2	46.3		42.9			38.1	75
80	50.6	49.4		49.4	48.5				46.9	46.2		42.7	41.4		38.1	80
85	50.2	48.6	48.2	49.1	47.8				46.7	45.8		42.6	41.7		38	85
90	49.3	47.8	47.2	48.8	47.1				46.6	45.2		42.6	41.5		38	90
95	47.2	47.2	46.1	48.5	46.5	45.9			46.5	44.8		42.5	41.3		38	95
100	44.3	46.8	44.9	48.1	46.1	45.1			46.5	44.4	43.7	42.5	41.1		38	100
105	39.6	45.9	43.9	44.7	45.9	44.5			46.2	44.1	43.2	42.5	40.9	39.1	38	105
110	34.3	44.1	43.2	39.7	45.9	44			42.8	44	42.6	42.4	40.8	39.5	38	110
115	28.6	40	42.8	34.4	45.5	43.6			38.4	44	42.1	41.6	40.7	39.6	38	115
120		35	42.2	27.1	41.7	43.4			32.7	43.7	41.8	37.1	40.7	39.2	37.6	120
125			39.6		36.7	43.3				42	41.5		40.7	38.9	35.5	125
130			34.4			41.6				37.3	39.7		40.7	38.1	36.6	130
135						38.2					37.9		38.3	36.4	36.6	135
140											36.2			34.8	36.1	140
145														33.3		145
150														31.9		150
155															28.6	155

* adapter · pièce d'adaptateur

t_240_004_50601_00_000

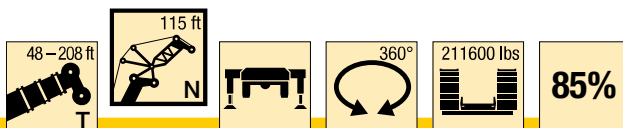

ft	128 + 11.5 ft*			144 + 11.5 ft*			160 + 11.5 ft*			176 + 11.5 ft*			192 + 11.5 ft*			208 + 11.5 ft*			ft
	115 ft			115 ft			115 ft			115 ft			115 ft			115 ft			
	82°	75°	68°	82°	75°	68°	82°	75°	68°	82°	75°	68°	82°	75°	68°	82°	75°	68°	
60	33.5																		60
65	33.4			28					20.6										65
70	33.4			28					20.5			16.8							70
75	33.3			28					20.3			16.7			12.3				75
80	33.3			28					20.2			16.6			12.2			7.5	80
85	33.3			28					20.1			16.5			12			7.3	85
90	33.2	31.6		28					20			16.5			11.9			7.2	90
95	33.2	31.8		28					19.9			16.4			11.8			7.2	95
100	33.2	32.1		28	26.6				19.8			16.4			11.7			7.1	100
105	33.2	32.2		28	26.8				19.8	19.3		16.3			11.6			7	105
110	33.2	32.2		28	27				19.8	19.2		16.3	15.9		11.5			6.9	110
115	33.2	32.2		28	27.1				19.8	19.1		16.3	15.8		11.5			6.9	115
120	33.2	32.2	29.8	28	27.2				19.8	19.1		16.3	15.7		11.4	10.6		6.9	120
125	33.2	32.2	30.2	28	27.2				19.8	19		16.3	15.6		11.4	10.5		6.9	125
130		32.2	30.6	28	27.2	25			19.8	19		16.3	15.5		11.4	10.4		6.9	130
135		32.2	31		27.1	25.2			19			16.3	15.4		11.4	10.3		6.9	135
140		32.2	30.9		27.1	25.2			19	18.5		16.3	15.4		11.4	10.3		6.9	140
145		32.2	29.7		27.1	24.7			19	18.4		16.3	15.4		11.4	10.2		6.9	145
150			28.5		27.1	24.1			19	18.3		16.3	15.4	14.6	11.4	10.2		6.9	150
155			27.3			23.6			19	18.2		16.3	15.4	14.6	11.4	10.2		6.9	155
160			26.2			23.2				18.2		16.3	15.4	14.5	11.4	10.2	9.6	6.9	160
165						22.7				18.1		16.3	15.4	14.2	11.4	10.2	9.7	6.9	165
170										17.9		16.3	15.4	14.2	11.4	10.2	9.7	6.9	170
175										17.6		16.3	15.4	14.2	11.4	10.2	9.7	6.9	175
180												16.3	15.4	14.2	11.4	10.2	9.6	6.9	180
185												16.3	15.4	14.2	11.4	10.2	9.6	6.9	185
190												16.3	15.4	14.2	11.4	10.2	9.6	6.9	190

* adapter · pièce d'adaptateur

t_240_004_50601_00_000

Lifting capacities Forces de levage

TN

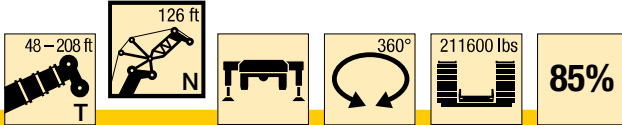

ft	48 + 11.5 ft*			64 + 11.5 ft*			80 + 11.5 ft*			96 + 11.5 ft*			112 + 11.5 ft*			ft
	126 ft			126 ft			126 ft			126 ft			126 ft			
	82°	75°	68°	82°	75°	68°	82°	75°	68°	82°	75°	68°	82°	75°	68°	
50	49.1															50
55	48.5			46.3			43.1									55
60	47.9			45.8			42.7						38.6		34	60
65	47.3			45.4			42.4						38.4		34	65
70	46.5			45			42.1						38.2		33.9	70
75	45.8	45.4		44.5	43.9		41.8						38		33.8	75
80	45.2	44.6		44.1	43.7		41.6	40.6					37.9		33.7	80
85	44.6	43.8		43.7	43.1		41.4	40.7					37.7	36.5	33.6	85
90	44.2	43		43.4	42.5		41.2	40.4					37.6	36.6	33.5	90
95	43.8	42.4	42	43.1	41.9		41.1	40.1					37.5	36.6	33.5	95
100	43.1	41.8	41.2	42.8	41.4	41	41	39.8					37.5	36.5	33.5	100
105	42.1	41.4	40.4	41.9	40.9	40.4	40.7	39.4	38.4				37.5	36.3	33.5	105
110	40	41.1	39.7	40.8	40.7	39.7	40.1	39.1	38.5				37.5	36.2	33.5	110
115	36	40.7	39	38.4	40.5	39.2	39.2	39	38				37.5	36.1	34.6	115
120	31.6	39.6	38.5	35.3	40	38.8	37.4	38.8	37.6				37.3	36.1	34.9	120
125	26.9	36.4	38.2	31.1	39.1	38.5	34.4	38.6	37.2				36.6	36	34.9	125
130		32.4	37.8	26.2	36.9	38.4	29.9	38.2	37				33.3	36	34.7	130
135		27	36.1		33.2	38.4		37	36.8				28.7	36	34.5	135
140			32.2		28	37.5		33.8	36					35.9	34.2	140
145						34.6			34.4					34	33	145
150						28.9			33					29.3	31.7	150
155									31						30.4	155
160															29.2	160
165															26.1	165

* adapter · pièce d'adaptateur

t_240_004_50701_00_000

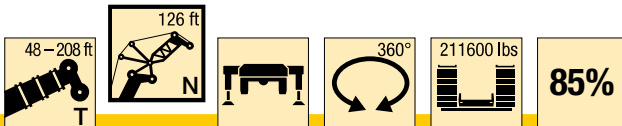

ft	128 + 11.5 ft*			144 + 11.5 ft*			160 + 11.5 ft*			176 + 11.5 ft*			192 + 11.5 ft*			208 + 11.5 ft*			ft
	126 ft			126 ft			126 ft			126 ft			126 ft			126 ft			
	82°	75°	68°	82°	75°	68°	82°	75°	68°	82°	75°	68°	82°	75°	68°	82°	75°	68°	
65	29.6																		65
70	29.6			24.7			18.2												70
75	29.6			24.7			18.1			14.8									75
80	29.5			24.7			18			14.7					10.3		5.8		80
85	29.4			24.6			17.9			14.6					10.1		5.8		85
90	29.4			24.6			17.8			14.6					10		5.7		90
95	29.4			24.6			17.7			14.5					9.9		5.6		95
100	29.3	28.1		24.6			17.7			14.4					9.8		5.5		100
105	29.3	28.3		24.6	23.4		17.6			14.4					9.7		5.4		105
110	29.3	28.4		24.6	23.5		17.5	17.1		14.3					9.6		5.4		110
115	29.3	28.5		24.6	23.7		17.5	16.9		14.3	13.5				9.5		5.3		115
120	29.3	28.5		24.6	23.9		17.5	16.8		14.2	13.4				9.5		5.3		120
125	29.3	28.5		24.6	23.9		17.5	16.8		14.2	13.3				9.5	8.6	5.2		125
130	29.3	28.5	26.5	24.6	24		17.5	16.8		14.2	13.2				9.4	8.6	5.2	4.4	130
135	29.3	28.4	26.8	24.6	24		17.5	16.8		14.2	13.1				9.4	8.5	5.2	4.4	135
140	29	28.4	27.2	24.6	24.1	22.1	17.5	16.8		14.2	13.1				9.4	8.4	5.2	4.3	140
145		28.4	27.5		24.1	22.4	17.5	16.8	16.4	14.2	13.1				9.4	8.4	5.2	4.3	145
150		28.4	27.7		24.1	22.4		16.8	16.3		13.1					8.4	5.2	4.2	150
155		28.4	26.9		24.1	22.2		16.8	16.2		13.1	12.3				8.4		4.2	155
160			25.9		24.1	21.8		16.8	16.1		13.1	12.5				8.4		4.2	160
165			24.8			21.4		16.8	16.1		13.1	12.6				8.4	7.9	4.2	165
170			23.9			21			16			13.1	12.6			8.4	8	4.2	170
175						20.7			16			12.5	12.6			8.4	8.1	4.2	175
180						20.1			16			12.4	12.4				8.2	4	180
185									15.9			12.1	12.1				8.3	4.2	185
190												11.9	11.9				8.3	4.3	190
195																	8.1	4.3	195
200																		4.2	200

* adapter · pièce d'adaptateur

t_240_004_50701_00_000

Lifting capacities Forces de levage

TN

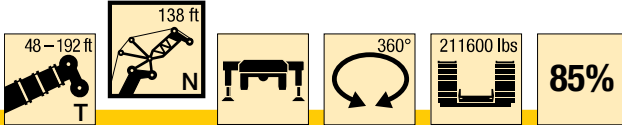

ft	48 + 11.5 ft*			64 + 11.5 ft*			80 + 11.5 ft*			96 + 11.5 ft*			112 + 11.5 ft*			ft		
	138 ft			138 ft			138 ft			138 ft			138 ft					
	82°	75°	68°	82°	75°	68°	82°	75°	68°	82°	75°	68°	82°	75°	68°			
55	43.2			41												55		
60	42.7			40.7			37.9									60		
65	42.1			40.3			37.7						34.1		30.1	65		
70	41.6			40			37.4						33.9		30	70		
75	41			39.6			37.1						33.7		29.9	75		
80	40.5	40.3		39.2	38.6		36.9						33.5		29.8	80		
85	40	39.6		38.9	38.5		36.7	35.7					33.4		29.7	85		
90	39.5	38.9		38.6	38.2		36.5	35.8					33.3	32.1	29.6	90		
95	38.9	38.2		38.3	37.7		36.3	35.7					33.1	32.2	29.6	95		
100	38	37.7	37.6	37.6	37.2		36	35.4					33	32.3	29.6	100		
105	37.2	37.2	36.8	36.9	36.8	36.4	35.7	35.2					33	32.2	29.5	105		
110	35.9	36.7	36.2	35.9	36.5	36	35.4	35	33.6				33	32.1	29.5	110		
115	34.7	35.9	35.6	34.7	36	35.5	34.5	34.7	33.8				32.8	32	29.5	115		
120	33.2	35	35.1	33.6	35.1	34.9	33.4	34.4	33.8				32.3	31.8	30.2	120		
125	31.3	33.8	34.6	32.5	34.3	34.6	32.4	33.9	33.5				31.8	31.8	30.5	125		
130	28.5	32.7	33.9	31.1	33.2	34.2	31.5	33.3	33.2				31.1	31.8	30.8	130		
135	24.7	31.6	32.9	28	32.1	33.5	29.8	32.3	32.9				30.2	31.7	30.8	135		
140	20.1	29.2	31.9	24.2	31.2	32.7	27.1	31.4	32.6				28.8	31.1	30.7	140		
145		25.2	30.9		29.3	31.7		30.5	32.1				26.5	30.5	30.5	145		
150			29		26	30.8		29.4	31.3				29.7	30.4	30.4	150		
155						29.9		26.4	30.4					29.1	30	28.5	155	
160						27.4			29.7					27	28.8	28.1	160	
165									28.6						27.7	26.9	25.7	165
170															26.6		24.7	170
175																	23.8	175
180																	22.8	180

* adapter · pièce d'adaptateur

t_240_004_50801_00_000

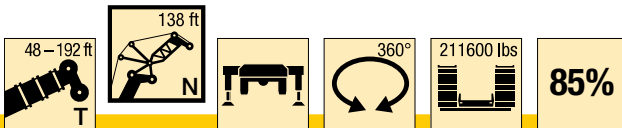

ft	128 + 11.5 ft*			144 + 11.5 ft*			160 + 11.5 ft*			176 + 11.5 ft*			192 + 11.5 ft*			ft	
	138 ft			138 ft			138 ft			138 ft			138 ft				
	82°	75°	68°	82°	75°	68°	82°	75°	68°	82°	75°	68°	82°	75°	68°		
70	26.1			21.9												70	
75	26			21.9			15.9									75	
80	25.9			21.8			15.9					12.8				80	
85	25.9			21.8			15.8					12.7			8.3	85	
90	25.8			21.8			15.7					12.6			8.1	90	
95	25.8			21.8			15.7					12.5			8.1	95	
100	25.8			21.8			15.6					12.3			7.9	100	
105	25.7	24.7		21.8			15.6					12.2			7.9	105	
110	25.7	24.8		21.8	20.7		15.5					12.1			7.8	110	
115	25.7	24.9		21.8	20.8		15.4	15				12			7.7	115	
120	25.7	25		21.8	21		15.4	14.9				11.9	11.3		7.6	120	
125	25.7	25		21.8	21.1		15.4	14.8				11.9	11.2		7.6	125	
130	25.7	25		21.8	21.2		15.4	14.7				11.9	11.1		7.5	130	
135	25.7	25	23.1	21.8	21.2		15.4	14.7				11.9	11		7.5	135	
140	25.7	24.9	23.3	21.8	21.3		15.4	14.6				11.9	10.9		7.5	140	
145	25.3	24.9	23.6	21.8	21.2	19.4	15.4	14.6				11.9	10.9		7.5	145	
150	24.9	24.9	23.9	21.8	21.2	19.6	15.4	14.6	14.2			11.9	10.9		7.5	150	
155		24.9	24.2		21.2	19.9	15.4	14.6	14.2			11.9	10.9		7.5	155	
160		24.9	24.3		21.2	20.1		14.6	14.1				10.9		7.5	160	
165		24.9	24.3		21.2	20		14.6	14.1				10.9	10.5	6.6	165	
170			23.8		21.2	19.7		14.6	14.1				10.9	10.7	6.6	170	
175			22.9			19.4		14.6	14.1				10.9	10.8	6.6	175	
180			22			19.1			14				10.9	10.9	6.6	180	
185			21.2			18.8			14				10.9	10.9	6.6	185	
190						18.3			14					10.8	6.6	6.7	190
195									14					10.7	6.6	6.7	195
200														10.5	6.6	6.6	200
205															6.6	6.6	205

* adapter · pièce d'adaptateur

t_240_004_50801_00_000

Lifting capacities Forces de levage

TN

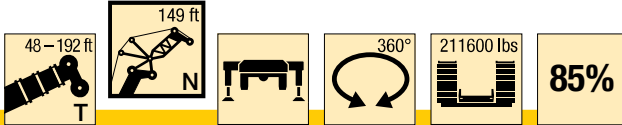

ft	48 + 11.5 ft*			64 + 11.5 ft*			80 + 11.5 ft*			96 + 11.5 ft*			112 + 11.5 ft*			ft
	149 ft			149 ft			149 ft			149 ft			149 ft			
	82°	75°	68°	82°	75°	68°	82°	75°	68°	82°	75°	68°	82°	75°	68°	
60	37.8			35.9						30.1						60
65	37.4			35.7					33.3							65
70	36.9			35.4					33.1				26.5			70
75	36.5			35.1					32.8				26.3			75
80	36.1			34.8					32.6				26.3			80
85	35.8	35.5		34.5	33.7				32.4				26.2			85
90	35.4	35.1		34.3	33.7				32.2	31.3			26.1			90
95	35	34.5		34	33.6				32.1	31.4			26			95
100	34.6	34		33.8	33.3				31.9	31.4			26	25		100
105	34.3	33.5	33.4	33.6	33				31.8	31.2			25.9	25.1		105
110	34.1	33.1	32.9	33.5	32.7	31.7			31.7	31.1			25.9	25.2		110
115	33.8	32.6	32.2	33.3	32.4	31.9			31.6	30.9			25.9	25.3		115
120	33.6	32.3	31.7	33.2	32.1	31.6			31.6	30.7	29.5		25.9	25.2		120
125	33.3	32.1	31.3	33	31.9	31.2			31.5	30.6	29.7		25.9	25.1		125
130	31.4	32	30.9	32.4	31.7	30.9			31.5	30.5	29.8		25.9	25.1		130
135	28.6	32	30.7	30.5	31.7	30.6			30.8	30.4	29.6		25.9	25.1	23.5	135
140	25.7	31.3	30.5	28.3	31.7	30.4			29.7	30.3	29.4		25.9	25.1	23.7	140
145	22.6	29.2	30.4	25.5	31.2	30.2			27.8	30.3	29.2		25.9	25.1	24	145
150	19.2	26.5	30.2	22.3	29.6	30.1			24.8	30.2	29		25.9	25.1	24.3	150
155		23.4	29.1		27.3	30.1			21.4	29.7	29		25.6	25.1	24.3	155
160		18.7	26.8		24	29.8				27.8	29		24.1	25.1	24.3	160
165			23.1			28.5				24.6	28.7			25.1	24.3	165
170						25.3					27.6			25.1	24.3	170
175											26.4			24.9	23.8	175
180														24.4	22.9	180
185														24.4	22	185
190														23.5	21.2	190

* adapter · pièce d'adaptateur

t_240_004_50901_00_000

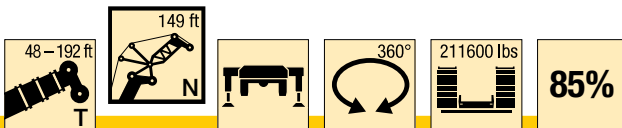

ft	128 + 11.5 ft*			144 + 11.5 ft*			160 + 11.5 ft*			176 + 11.5 ft*			192 + 11.5 ft*			ft
	149 ft			149 ft			149 ft			149 ft			149 ft			
	82°	75°	68°	82°	75°	68°	82°	75°	68°	82°	75°	68°	82°	75°	68°	
70	23.1															70
75	23.1			19.4												75
80	23			19.4					14.1							80
85	23			19.4					14				6.8			85
90	22.9			19.3					14				6.7			90
95	22.9			19.3					13.9				6.6			95
100	22.8			19.3					13.8				6.5			100
105	22.8			19.3					13.8				6.4			105
110	22.8	21.8		19.3					13.7				6.3			110
115	22.8	21.9		19.3	18.3				13.7				6.3			115
120	22.8	22.1		19.3	18.4				13.6	13.3			6.2			120
125	22.8	22.1		19.3	18.5				13.6	13.2			6.1			125
130	22.8	22.1		19.3	18.6				13.6	13.1			6.1			130
135	22.8	22.2		19.3	18.7				13.5	13			6.1	5.4		135
140	22.8	22.2	20.3	19.3	18.8				13.5	12.9			6	5.3		140
145	22.8	22.2	20.5	19.3	18.8				13.5	12.8			6	5.2		145
150	22.8	22.2	20.7	19.3	18.8	17			13.5	12.8			6	5.2		150
155	22.8	22.3	21	19.3	18.8	17.2			13.5	12.8			6	5.2		155
160	22.8	22.3	21.2	19.3	18.7	17.4			13.5	12.8	12.5		6	5.2		160
165		22.3	21.4	19.3	18.7	17.7			13.5	12.8	12.5		6	5.2		165
170		22.3	21.6		18.7	17.8				12.8	12.4	10	6	5.2		170
175		22.3	21.7		18.7	17.9				12.8	12.4		6	5.2		175
180		22.3	21.7		18.7	17.8				12.8	12.4		6	5.2	5.1	180
185			21		18.7	17.6				12.8	12.3		6	5.2	5.2	185
190			20.2			17.3					12.3		6	5.2	5.3	190
195			19.4			17.1					12.3		6	5.2	5.3	195
200						16.7					12.3		6	5.2	5.4	200
205											12.3		6	5.2	5.3	205
210											12.3		6	5.2	5.3	210
215											12.3		6	5.2	5.3	215
220											12.3		6	5.2	5.3	220

* adapter · pièce d'adaptateur

t_240_004_50901_00_000

Lifting capacities Forces de levage

TN

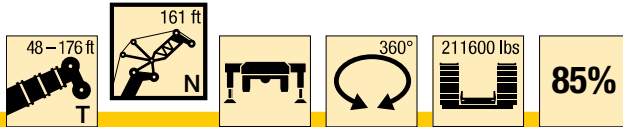

ft	48 + 11.5 ft*			64 + 11.5 ft*			80 + 11.5 ft*			96 + 11.5 ft*			112 + 11.5 ft*			128 + 11.5 ft*			144 + 11.5 ft*			160 + 11.5 ft*			176 + 11.5 ft*			ft
	161 ft			161 ft			161 ft			161 ft			161 ft			161 ft			161 ft			161 ft			161 ft			
	82°	75°	68°	82°	75°	68°	82°	75°	68°	82°	75°	68°	82°	75°	68°	82°	75°	68°	82°	75°	68°	82°	75°	68°	82°	75°	68°	
65	33.3			31.7																							65	
70	33			31.5			29.4			26.5																	70	
75	32.6			31.2			29.2			26.3			23.4			20.5											75	
80	32.3			31			29			26.2			23.3			20.4			17.1								80	
85	32			30.7			28.8			26.1			23.3			20.4			17.1			12.3			9.1		85	
90	31.6	31.3		30.5	29.7		28.6			26			23.2			20.3			17.1			12.3			8.9		90	
95	31.3	31.2		30.3	29.7		28.5	27.6		25.8			23.1			20.3			17			12.2			8.8		95	
100	30.9	30.7		30	29.7		28.3	27.6		25.7	24.8		23			20.2			17			12.1			8.7		100	
105	30.6	30.3		29.8	29.5		28.2	27.6		25.7	24.9		23	22.1		20.2			17			12.1			8.6		105	
110	30.3	29.8	29.4	29.7	29.3		28.1	27.6		25.6	25		23	22.2		20.2			17			12.1			8.5		110	
115	30.1	29.5	29.3	29.5	29.1		27.9	27.5		25.5	25		22.9	22.3		20.2	19.3		17			12			8.4		115	
120	29.9	29.1	28.9	29.4	28.8	27.9	27.9	27.3		25.4	24.9		22.9	22.3		20.2	19.4		17	16.2		12			8.3		120	
125	29.8	28.8	28.4	29.2	28.5	28	27.8	27.2	25.8	25.4	24.8		22.9	22.3		20.2	19.5		17	16.3		11.9	11.4		8.2		125	
130	29.7	28.6	28	29	28.3	27.9	27.7	27	26	25.3	24.7	23.1	22.9	22.3		20.2	19.6		17	16.3		11.9	11.3		8.2	7.6	130	
135	29.5	28.4	27.6	28.7	28.1	27.6	27.4	26.9	26.1	25.1	24.7	23.3	22.9	22.2		20.2	19.6		17	16.4		11.8	11.2		8.1	7.5	135	
140	27.8	28.3	27.3	28.1	28	27.3	27.2	26.9	26.1	25	24.6	23.5	22.9	22.2	20.7	20.2	19.6		17	16.5		11.8	11.1		8.1	7.4	140	
145	25.6	28.3	27.1	26.9	27.9	27.1	26.8	26.8	26.1	24.8	24.6	23.7	22.8	22.2	20.8	20.2	19.6	17.8	17	16.5		11.8	11.1		8.1	7.4	145	
150	23.2	27.7	26.9	25.4	27.9	26.9	26.3	26.7	25.9	24.7	24.6	23.9	22.8	22.2	21.1	20.2	19.6	17.9	17	16.5		11.8	11.1		8.1	7.4	150	
155	20.6	26.1	26.9	23	27.5	26.7	25.1	26.6	25.8	24.6	24.4	23.9	22.7	22.2	21.3	20.2	19.6	18.1	17	16.6	14.9	11.8	11.1		8.1	7.4	155	
160	17.8	24	26.9	20.4	26.5	26.6	22.6	26.5	25.7	24	24.3	23.8	22.7	22.2	21.5	20.2	19.6	18.3	17	16.6	15	11.8	11.1		8.1	7.4	160	
165		21.4	26.1	17.2	24.7	26.6	20	26.4	25.6	22.9	24.2	23.8	22.7	22.2	21.5	20.2	19.6	18.5	17	16.6	15.2	11.8	11.1	10.8	8.1	7.4	165	
170		18	24.4		22.1	26.5		25.1	25.6	20.3	24.2	23.8	21.8	22.2	21.5	20.2	19.6	18.7	17	16.6	15.4	11.8	11.1	10.8	8.1	7.4	170	
175			21.6			25.8		22.6	25.6		24.2	23.8		22.2	21.6		19.6	18.9	17	16.6	15.6	11.8	11.1	10.8	8.1	7.4	7.2	175
180						23.4		19	25.2		24	23.8		22.2	21.6		19.6	19		16.6	15.8		11.1	10.7	8.1	7.4	7.3	180
185									24.2			23.4		22.1	21.5		19.6	19		16.6	15.9		11.1	10.6		7.4	7.4	185
190									21.8			22.6			20.9		19.6	19		16.6	15.9		11.1	10.6		7.4	7.5	190
195												21.8			20.1			18.9		16.6	15.7		11.1	10.6		7.4	7.6	195
200															19.4			18.4			15.5		11.1	10.6		7.4	7.5	200
205																		17.7			15.4			10.6		7.4	7.5	205
210																					15.1			10.6			7.5	210
215																							10.6				7.5	215
220																							10.6				7.5	220
225																											7.5	225

* adapter · pièce d'adaptateur

t_240_004_51001_00_000

Lifting capacities Forces de levage

TN

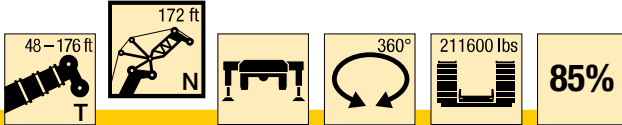

ft	48 + 11.5 ft*			64 + 11.5 ft*			80 + 11.5 ft*			96 + 11.5 ft*			112 + 11.5 ft*			128 + 11.5 ft*			144 + 11.5 ft*			160 + 11.5 ft*			176 + 11.5 ft*			ft
	172 ft			172 ft			172 ft			172 ft			172 ft			172 ft			172 ft			172 ft			172 ft			
	82°	75°	68°	82°	75°	68°	82°	75°	68°	82°	75°	68°	82°	75°	68°	82°	75°	68°	82°	75°	68°	82°	75°	68°	82°	75°	68°	
65	29.8																										65	
70	29.5			28.1			26.1																					70
75	29.2			27.9			25.9			23.5			20.8															75
80	28.9			27.6			25.7			23.4			20.8			18.1												80
85	28.6			27.4			25.6			23.3			20.7			18.1			15.1			10.7						85
90	28.3			27.2			25.4			23.1			20.6			18			15.1			10.6			7.3			90
95	28	27.6		27			25.2			23			20.6			18			15.1			10.6			7.1			95
100	27.7	27.6		26.8	26.2		25.1	24.3		22.9			20.5			17.9			15.1			10.5			7			100
105	27.4	27.3		26.6	26.3		25	24.3		22.8	22		20.4			17.9			15			10.4			6.9			105
110	27.1	27		26.4	26.1		24.8	24.3		22.7	22		20.4	19.6		17.9			15			10.3			6.8			110
115	26.8	26.6		26.3	26		24.7	24.3		22.7	22.1		20.3	19.7		17.9			15			10.2			6.8			115
120	26.7	26.3	25.9	26.1	25.7		24.6	24.2		22.6	22.1		20.3	19.7		17.8	17.1		15			10.1			6.7			120
125	26.5	25.9	25.8	25.9	25.5	24.5	24.3	24.1		22.5	22.1		20.3	19.8		17.8	17.2		15	14.2		10			6.6			125
130	26.3	25.6	25.5	25.7	25.4	24.6	24.1	24	22.7	22.4	22		20.3	19.8		17.8	17.2		15	14.3		10	9.4		6.5			130
135	26.1	25.4	25.1	25.4	25.2	24.7	23.9	23.8	22.8	22.3	22		20.3	19.7		17.8	17.3		15	14.3		9.9	9.4		6.5	5.7		135
140	25.9	25.2	24.8	25.2	25	24.6	23.7	23.7	22.9	22.2	21.9	20.5	20.3	19.7		17.8	17.3		15	14.3		9.9	9.3		6.4	5.7		140
145	25.6	25.1	24.5	25	24.9	24.4	23.4	23.5	23	22	21.8	20.6	20.2	19.7	18.1	17.8	17.3		15	14.3		9.9	9.2		6.4	5.7		145
150	24.3	25	24.3	24.5	24.8	24.2	23.2	23.3	23	21.8	21.7	20.8	20.1	19.6	18.3	17.8	17.3		15	14.3		9.9	9.2		6.4	5.7		150
155	22.8	25	24.1	23.7	24.6	24	23.1	23.1	22.9	21.7	21.6	21	20.1	19.6	18.4	17.8	17.3	15.7	15	14.3		9.9	9.2		6.4	5.8		155
160	20.9	24.5	23.9	22.9	24.4	23.8	23	22.9	22.8	21.6	21.5	21.1	20	19.6	18.6	17.8	17.3	15.8	15	14.3		9.9	9.2		6.4	5.9		160
165	18.7	23.3	23.9	20.8	24	23.7	22.4	22.7	22.7	21.5	21.4	21.1	19.9	19.6	18.8	17.8	17.3	16	15	14.3	13.1	9.9	9.2		6.4	6		165
170	16.3	21.7	23.8	18.6	23.5	23.7	21	22.6	22.6	21.2	21.2	21.1	19.9	19.6	18.9	17.8	17.3	16.2	15	14.3	13.2	9.9	9.2	9.1	6.4	6.1		170
175		19.5	23.3	16.1	22.4	23.7	19.1	22.5	22.4	20.6	21.1	21	19.9	19.5	19	17.8	17.3	16.4	15	14.3	13.4	9.9	9.2	9.2	6.4	6.2		175
180		16.9	22.1		20.2	23.7		22.2	22.3	18.6	21.1	20.9	19.5	19.4	19	17.8	17.3	16.6	15	14.3	13.6	9.9	9.2	9.2	6.4	6.3	5.7	180
185			19.9		17.4	23.2		21.3	22.2		21.1	20.8		19.4	19	17.8	17.3	16.7	15	14.3	13.7	9.9	9.2	9.2	6.4	6.4	5.8	185
190			16.5			21.4		18.8	22.2		21.1	20.7		19.4	19		17.3	16.8		14.3	13.9	9.9	9.2	9.2	6.4	6.5	5.9	190
195						18.4			22.2		19	20.7		19.4	19		17.3	16.8		14.3	14.1		9.2	9.2		6.5	6	195
200									21.1			20.7		19.3	19		17.3	16.8		14.3	14.1		9.2	9.2		6.4	6.1	200
205											20				18.4		16.8		14.3	14.1		9.2	9.2		6.4	6.2	205	
210															17.7		16.7			14		9.2	9.2		6.4	6.4	210	
215																	16.2				13.9		9.2		6.4	6.5	215	
220																	15.6					13.7		9.2		6.4	220	
225																						13.2		9.2		6.4	225	
230																							9.2		6.4	230		
235																								9.2		6.4	235	

* adapter · pièce d'adaptateur

t_240_004_51101_00_000

Lifting capacities Forces de levage

TN

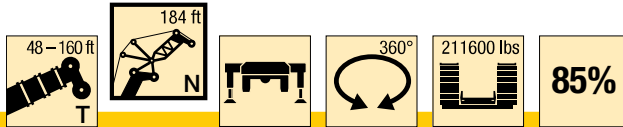

ft	48 + 11.5 ft*			64 + 11.5 ft*			80 + 11.5 ft*			96 + 11.5 ft*			112 + 11.5 ft*			128 + 11.5 ft*			144 + 11.5 ft*			160 + 11.5 ft*			ft
	184 ft			184 ft			184 ft			184 ft			184 ft			184 ft			184 ft						
	82°	75°	68°	82°	75°	68°	82°	75°	68°	82°	75°	68°	82°	75°	68°	82°	75°	68°	82°	75°	68°	82°	75°	68°	
70	26.1																							70	
75	25.9			24.7			23																	75	
80	25.6			24.5			22.9			20.8			18.4											80	
85	25.3			24.3			22.7			20.6			18.3			15.9								85	
90	25.1			24.1			22.6			20.5			18.3			15.9			13.2			8.9		90	
95	24.8			23.9			22.4			20.4			18.2			15.9			13.2			8.8		95	
100	24.6	24.1		23.7			22.3			20.3			18.1			15.8			13.2			8.7		100	
105	24.3	24.1		23.5	23		22.2	21.5		20.2			18.1			15.8			13.2			8.6		105	
110	24	24		23.3	23		22	21.5		20.1			18			15.8			13.1			8.5		110	
115	23.7	23.8		23	22.9		21.8	21.5		20.1	19.4		18	17.3		15.7			13.1			8.4		115	
120	23.4	23.5		22.7	22.8		21.7	21.5		20	19.5		17.9	17.3		15.7			13			8.3		120	
125	23.1	23.2	22.6	22.5	22.6		21.5	21.4		19.9	19.5		17.9	17.4		15.7	15		12.9			8.2		125	
130	22.9	22.9	22.6	22.2	22.4	21.4	21.3	21.3		19.8	19.5		17.9	17.4		15.7	15		12.9	12		8.2		130	
135	22.6	22.7	22.5	22	22.1	21.4	21	21.1		19.7	19.4		17.8	17.4		15.7	15.1		12.8	12		8.1	7.4	135	
140	22.3	22.4	22.2	21.7	21.8	21.5	20.8	20.9	19.9	19.5	19.4		17.8	17.4		15.7	15.1		12.7	12		8.1	7.4	140	
145	22.1	22.1	21.9	21.4	21.6	21.5	20.6	20.7	20	19.3	19.3	17.9	17.7	17.3		15.7	15.2		12.7	12		8.1	7.4	145	
150	21.8	21.9	21.7	21.2	21.3	21.4	20.4	20.5	20.1	19.1	19.1	18	17.7	17.3	15.8	15.7	15.2		12.7	12.1		8.1	7.5	150	
155	21.6	21.6	21.5	21	21.1	21.2	20.2	20.2	20.2	19	19	18.1	17.5	17.3	16	15.7	15.1		12.7	12.2		8.1	7.5	155	
160	21.2	21.5	21.3	20.8	20.8	21	20	20	20.1	18.8	18.9	18.3	17.4	17.2	16.1	15.7	15.1	13.7	12.7	12.3		8.1	7.6	160	
165	20.8	21.3	21.1	20.7	20.6	20.7	19.9	19.8	19.9	18.6	18.7	18.5	17.3	17.1	16.2	15.6	15.1	13.8	12.7	12.4		8.1	7.7	165	
170	19.7	21.1	21	20.6	20.5	20.5	19.8	19.7	19.7	18.5	18.5	18.5	17.2	17.1	16.4	15.6	15.1	13.9	12.7	12.6	11.3	8.1	7.8	170	
175	17.7	21	20.9	19.2	20.3	20.3	19.4	19.5	19.5	18.5	18.4	18.3	17.1	17	16.5	15.5	15.1	14.1	12.7	12.7	11.4	8.1	7.9	175	
180	15.6	20.4	20.8	17.6	20.3	20.2	18.6	19.4	19.4	18.4	18.2	18.2	17	16.9	16.6	15.5	15.1	14.2	12.7	12.7	11.6	8.1	8	7.5	180
185	13	18.5	20.8	15.6	19.9	20	17.4	19.4	19.2	18.3	18.1	18.1	17	16.8	16.6	15.4	15.1	14.4	12.7	12.8	11.7	8.1	8	7.6	185
190		16.2	20.4		19	20	15.2	19.3	19.1	17	18.1	18	17	16.7	16.6	15.4	15.1	14.6	12.7	12.8	11.9	8.1	8.1	7.7	190
195			18.9		16.9	20		19.1	19.1		18.1	17.9	16	16.7	16.5	15.3	15.1	14.7	12.7	12.7	12.2	8.1	8.1	7.7	195
200			16.5			19.7		17.3	19.1		18.1	17.8		16.7	16.5	15.1	14.8		12.7	12.2		8.1	8.1	7.7	200
205						18			19.1		17.3	17.8		16.7	16.4	15.1	14.8		12.7	12.4		8.1	8.1	7.7	205
210									18.8			17.8		16.7	16.4	15.1	14.8		12.7	12.5		8.1	7.8	210	
215												17.8			16.4	15.1	14.8		12.7	12.5		8.1	7.8	215	
220															16.1		14.9			12.4		8.1	7.8	220	
225															15.6		14.7			12.2			7.8	225	
230																	14.1			12.2			7.9	230	
235																				11.8			7.9	235	
240																							8	240	

* adapter · pièce d'adaptateur

t_240_004_51201_00_000

Lifting capacities Forces de levage

TN

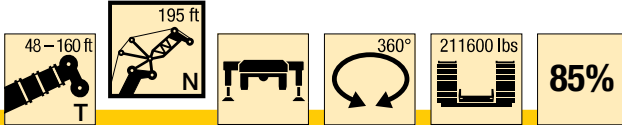

ft	48 + 11.5 ft*			64 + 11.5 ft*			80 + 11.5 ft*			96 + 11.5 ft*			112 + 11.5 ft*			128 + 11.5 ft*			144 + 11.5 ft*			160 + 11.5 ft*			ft
	195 ft			195 ft			195 ft			195 ft			195 ft			195 ft			195 ft			195 ft			
	82°	75°	68°	82°	75°	68°	82°	75°	68°	82°	75°	68°	82°	75°	68°	82°	75°	68°	82°	75°	68°	82°	75°	68°	
75	22.9			21.8																				75	
80	22.6			21.6			20.2			18.3														80	
85	22.4			21.4			20.1			18.2			16.2											85	
90	22.2			21.3			19.9			18.1			16.1			14			11.5					90	
95	22			21.1			19.8			18			16.1			14			11.5		7.3			95	
100	21.8			20.9			19.7			17.9			16			13.9			11.6		7.2			100	
105	21.5	21		20.7			19.5			17.9			15.9			13.9			11.5		7.1			105	
110	21.3	21		20.6	20.1		19.4			17.8			15.9			13.9			11.4		7			110	
115	21	20.9		20.4	20.1		19.3	18.8		17.7			15.8			13.8			11.3		6.9			115	
120	20.7	20.8		20.1	20		19.1	18.8		17.6	17		15.8			13.8			11.2		6.8			120	
125	20.3	20.5		19.8	20		18.9	18.8		17.5	17.1		15.7	15.2		13.8			11.1		6.7			125	
130	20.1	20.2	19.6	19.5	19.7		18.7	18.8		17.4	17.1		15.7	15.2		13.7	13.1		11		6.6			130	
135	19.8	20	19.6	19.3	19.4		18.5	18.6		17.3	17.1		15.6	15.3		13.7	13.2		11	10.2	6.6			135	
140	19.6	19.7	19.6	19.1	19.2	18.7	18.3	18.4		17.2	17		15.6	15.3		13.7	13.2		10.9	10.2	6.6	6		140	
145	19.3	19.4	19.6	18.8	19	18.7	18.1	18.2	17.3	17	17		15.5	15.3		13.7	13.3		10.9	10.2	6.5	6		145	
150	19.1	19.2	19.3	18.6	18.7	18.7	17.9	18	17.4	16.8	16.9	15.6	15.5	15.2		13.7	13.3		10.9	10.3	6.5	6		150	
155	18.9	18.9	19.1	18.4	18.5	18.6	17.7	17.8	17.5	16.6	16.7	15.7	15.4	15.2		13.7	13.2		10.9	10.3	6.5	6		155	
160	18.7	18.7	18.8	18.2	18.3	18.4	17.5	17.6	17.5	16.5	16.6	15.7	15.3	15.1	13.9	13.7	13.2		10.9	10.4	6.5	6.1		160	
165	18.5	18.5	18.6	18	18.1	18.2	17.3	17.4	17.5	16.3	16.4	15.9	15.1	15.1	14	13.7	13.2	11.9	10.9	10.5	6.5	6.2		165	
170	18.4	18.3	18.4	17.8	17.9	17.9	17.1	17.2	17.3	16.2	16.3	16	15	15	14.1	13.6	13.2	12	10.9	10.6	6.5	6.3		170	
175	18.2	18.2	18.2	17.7	17.7	17.7	17	17	17.1	16	16.1	16.1	14.9	14.9	14.2	13.5	13.2	12.1	10.9	10.8	9.8	6.5	6.4		175
180	17.5	18.1	18	17.6	17.6	17.6	16.9	16.9	16.9	16	15.9	16	14.8	14.7	14.3	13.5	13.2	12.2	10.9	10.9	9.9	6.5	6.5		180
185	16	18	17.9	16.8	17.4	17.4	16.7	16.7	16.8	15.9	15.8	15.8	14.8	14.6	14.4	13.4	13.2	12.3	10.9	10.9	10	6.5	6.6	6.1	185
190	14.3	17.6	17.8	15.9	17.3	17.3	16.4	16.6	16.6	15.9	15.7	15.7	14.7	14.5	14.4	13.4	13.2	12.5	10.9	11	10.1	6.5	6.6	6.2	190
195	12.2	16.6	17.7	14.3	17.2	17.2	15.8	16.6	16.5	15.9	15.6	15.6	14.7	14.5	14.4	13.3	13.2	12.6	10.9	11.1	10.2	6.5	6.5	6.3	195
200		15	17.6		16.9	17.1	14.1	16.6	16.4	15.2	15.6	15.4	14.7	14.4	14.3	13.3	13.1	12.8	10.9	11.1	10.3	6.5	6.5	6.4	200
205		12.4	17.1		15.6	17.1		16.6	16.3		15.5	15.4	14.4	14.4	14.2	13.3	13.1	12.9	10.9	11.1	10.5	6.5	6.5	6.5	205
210			15.4			17.1		15.7	16.3		15.5	15.3		14.4	14.2		13.1	12.8	10.9	11	10.7	6.5	6.5	6.6	210
215						16.5			16.3		15.4	15.3		14.4	14.2		13.1	12.8		11	10.8		6.5	6.5	215
220									16.3			15.3		14.4	14.1		13.1	12.8		11	10.9		6.5	6.5	220
225									15.1			15.3			14.1		13.1	12.8		11	11		6.5	6.5	225
230												15.3			14.1		12.8		11	11		6.5	6.5	230	
235															14.1		12.8			11		6.5	6.5	235	
240																	12.8			10.9			6.5	240	
245																				10.7			6.5	245	
250																							6.5	250	
255																							6.5	255	

* adapter · pièce d'adaptateur

t_240_004_51301_00_000

Lifting capacities Forces de levage

TN

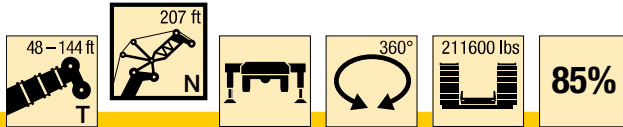

ft	48 + 11.5 ft*			64 + 11.5 ft*			80 + 11.5 ft*			96 + 11.5 ft*			112 + 11.5 ft*			128 + 11.5 ft*			144 + 11.5 ft*			ft	
	207 ft			207 ft			207 ft			207 ft			207 ft			207 ft			207 ft				
	82°	75°	68°	82°	75°	68°	82°	75°	68°	82°	75°	68°	82°	75°	68°	82°	75°	68°	82°	75°	68°		
80	20.2			19.2																		80	
85	20			19.1				17.8			16.1											85	
90	19.8			18.9				17.7			16			14.2			12.1					90	
95	19.6			18.7				17.5			15.9			14.1			12.1			9.8		95	
100	19.4			18.6				17.4			15.8			14.1			12.1			9.8		100	
105	19.1			18.4				17.3			15.8			14			12.1			9.7		105	
110	18.9	18.5		18.2				17.2			15.7			14			12.1			9.6		110	
115	18.6	18.4		18.1	17.7			17.1			15.6			13.9			12.1			9.4		115	
120	18.4	18.4		17.8	17.6			16.9	16.5		15.5			13.9			12			9.3		120	
125	18.1	18.2		17.6	17.6			16.7	16.5		15.4	14.9		13.8			12			9.3		125	
130	17.8	18		17.3	17.5			16.5	16.5		15.3	14.9		13.7	13.3		12			9.2		130	
135	17.5	17.7	17.1	17.1	17.3			16.3	16.5		15.2	15		13.7	13.3		11.9	11.3		9.2		135	
140	17.3	17.4	17.1	16.8	17			16.1	16.3		15.1	15		13.7	13.3		11.9	11.3		9.2	8.4	140	
145	17	17.2	17.1	16.6	16.8	16.2		15.9	16.1		15	14.9		13.6	13.3		11.9	11.4		9.2	8.4	145	
150	16.8	16.9	17.1	16.4	16.5	16.3		15.7	15.9	15.1	14.8	14.9		13.5	13.3		11.8	11.4		9.2	8.5	150	
155	16.6	16.7	16.9	16.1	16.3	16.3		15.5	15.7	15.1	14.6	14.7		13.4	13.2		11.8	11.4		9.2	8.5	155	
160	16.4	16.5	16.6	15.9	16	16.2		15.3	15.4	15.2	14.4	14.6	13.6	13.3	13.2		11.8	11.5		9.2	8.6	160	
165	16.2	16.2	16.4	15.7	15.8	16		15.1	15.2	15.2	14.2	14.4	13.7	13.2	13.1	12	11.8	11.5		9.2	8.7	165	
170	16	16	16.1	15.6	15.6	15.8		15	15.1	15.1	14.1	14.2	13.7	13	13	12.1	11.8	11.4		9.2	8.7	170	
175	15.8	15.8	15.9	15.4	15.4	15.6		14.8	14.9	15	13.9	14	13.8	12.9	12.9	12.2	11.7	11.4	10.3	9.2	8.8	175	
180	15.7	15.7	15.7	15.3	15.3	15.4		14.7	14.7	14.8	13.8	13.9	13.8	12.8	12.8	12.3	11.6	11.4	10.4	9.2	8.9	8.2	180
185	15.6	15.5	15.6	15.2	15.2	15.2		14.6	14.5	14.6	13.7	13.7	13.7	12.7	12.7	12.4	11.5	11.4	10.5	9.2	9.1	8.3	185
190	15.1	15.4	15.4	15	15	15		14.5	14.4	14.5	13.7	13.6	13.6	12.6	12.6	12.4	11.4	11.4	10.6	9.2	9.2	8.4	190
195	14	15.3	15.3	14.6	14.9	14.9		14.4	14.3	14.3	13.6	13.5	13.5	12.6	12.5	12.4	11.4	11.3	10.7	9.2	9.2	8.5	195
200	12.9	15.2	15.2	14.1	14.8	14.8		14.4	14.2	14.2	13.6	13.4	13.4	12.5	12.4	12.4	11.4	11.3	10.8	9.2	9.3	8.6	200
205	11.2	14.6	15.2	13	14.8	14.7		14.1	14.2	14.1	13.6	13.4	13.3	12.5	12.3	12.3	11.4	11.2	10.9	9.2	9.4	8.7	205
210		13.7	15.1	11.3	14.8	14.7		12.7	14.2	14	13.3	13.3	13.2	12.5	12.3	12.2	11.4	11.2	11	9.2	9.3	8.8	210
215		11.6	15		14.1	14.6			14.2	14	12.2	13.3	13.2	12.3	12.3	12.2	11.3	11.1	11	9.2	9.3	9	215
220			14.1			14.6			13.8	14		13.3	13.1		12.3	12.1	10.8	11.1	11	9.1	9.3	9.2	220
225					14.4				12.4	13.9		13.3	13.1		12.3	12.1		11.1	10.9		9.3	9.3	225
230										13.9			13.1		12.3	12		11.1	10.9		9.3	9.3	230
235										13.8			13.1			12		11.1	10.9		9.3	9.3	235
240													13.1			12			10.9		9.3	9.3	240
245																12			10.9			9.3	245
250																			10.9			9.3	250
255																						9.3	255
260																						9.2	260

* adapter · pièce d'adaptateur

t_240_004_51401_00_000

Lifting capacities Forces de levage

TN

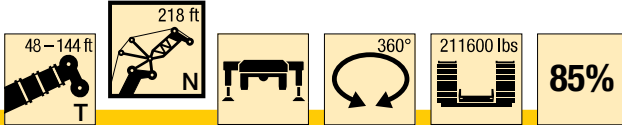

ft	48 + 11.5 ft*			64 + 11.5 ft*			80 + 11.5 ft*			96 + 11.5 ft*			112 + 11.5 ft*			128 + 11.5 ft*			144 + 11.5 ft*			ft
	218 ft			218 ft			218 ft			218 ft			218 ft			218 ft			218 ft			
	82°	75°	68°	82°	75°	68°	82°	75°	68°	82°	75°	68°	82°	75°	68°	82°	75°	68°	82°	75°	68°	
80	17.9																					80
85	17.8			17			15.7															85
90	17.7			16.9			15.7			14.2			12.3									90
95	17.5			16.7			15.6			14.1			12.3			10.4						95
100	17.3			16.6			15.5			14			12.3			10.4			8.1			100
105	17.1			16.4			15.4			14			12.2			10.4			8			105
110	16.9			16.3			15.3			13.9			12.2			10.4			7.9			110
115	16.7	16.4		16.1			15.2			13.8			12.2			10.4			7.8			115
120	16.4	16.3		15.9	15.6		15.1			13.7			12.2			10.4			7.6			120
125	16.2	16.2		15.7	15.6		15	14.5		13.6			12.1			10.4			7.6			125
130	16	16.1		15.5	15.5		14.8	14.5		13.6	13.1		12.1			10.3			7.5			130
135	15.7	15.8		15.3	15.4		14.6	14.5		13.5	13.1		12	11.5		10.3			7.4			135
140	15.4	15.6		15	15.2		14.4	14.5		13.3	13.1		12	11.5		10.3	9.8		7.4			140
145	15.2	15.4	15.1	14.8	15		14.2	14.4		13.2	13.1		12	11.6		10.3	9.9		7.4	6.8		145
150	15	15.1	15.1	14.6	14.7	14.2	14	14.2		13.1	13.1		11.9	11.6		10.3	9.9		7.4	6.8		150
155	14.8	14.9	15	14.4	14.5	14.3	13.8	14	13.2	13	13		11.9	11.5		10.3	9.9		7.4	6.9		155
160	14.6	14.7	14.8	14.2	14.3	14.3	13.6	13.8	13.2	12.8	12.9		11.7	11.5		10.2	9.9		7.4	7		160
165	14.4	14.5	14.6	14	14.1	14.2	13.4	13.6	13.3	12.6	12.7	11.9	11.6	11.5		10.2	9.9		7.4	7		165
170	14.2	14.3	14.4	13.8	13.9	14	13.2	13.3	13.3	12.4	12.6	11.9	11.5	11.4	10.4	10.2	9.9		7.4	7.1		170
175	14	14.1	14.2	13.7	13.7	13.8	13.1	13.1	13.2	12.3	12.4	12	11.3	11.3	10.5	10.2	9.9		7.4	7.2		175
180	13.8	13.9	14	13.5	13.5	13.6	13	13	13.1	12.2	12.2	12	11.2	11.2	10.6	10.1	9.9	8.8	7.4	7.3		180
185	13.7	13.7	13.8	13.3	13.4	13.4	12.8	12.8	13	12.1	12.1	12	11.2	11.2	10.6	10.1	9.9	8.8	7.4	7.3		185
190	13.6	13.6	13.6	13.2	13.2	13.3	12.7	12.7	12.8	11.9	12	12	11.1	11.1	10.7	10	9.9	8.9	7.4	7.4	7	190
195	13.5	13.5	13.5	13.1	13.1	13.1	12.6	12.6	12.7	11.9	11.9	11.9	11	11	10.8	9.9	9.8	9	7.4	7.5	7.1	195
200	13.2	13.4	13.4	13.1	13	13	12.5	12.5	12.5	11.8	11.8	11.8	10.9	10.9	10.8	9.9	9.8	9.1	7.4	7.6	7.2	200
205	12.4	13.3	13.3	12.8	12.9	12.9	12.5	12.4	12.4	11.8	11.7	11.7	10.9	10.8	10.8	9.8	9.7	9.3	7.4	7.6	7.3	205
210	11.5	13.2	13.2	12.5	12.8	12.8	12.5	12.3	12.3	11.7	11.6	11.6	10.9	10.7	10.7	9.8	9.7	9.4	7.4	7.5	7.3	210
215	10.2	12.8	13.1	11.7	12.8	12.7	12.4	12.3	12.2	11.7	11.5	11.5	10.9	10.6	10.6	9.8	9.6	9.4	7.4	7.5	7.4	215
220		12.4	13.1	10.2	12.8	12.7	11.5	12.2	12.1	11.6	11.5	11.4	10.8	10.6	10.6	9.7	9.6	9.5	7.4	7.5	7.5	220
225		10.6	13.1		12.5	12.6		12.2	12.1	11.1	11.5	11.4	10.5	10.6	10.5	9.5	9.6	9.5	7.4	7.5	7.5	225
230			12.7		11.2	12.6		12.2	12.1		11.5	11.3		10.6	10.4	9	9.6	9.4	7.4	7.5	7.6	230
235			10.7			12.6		11.4	12		11.5	11.3		10.6	10.4		9.6	9.4		7.5	7.5	235
240						12			12		11.3	11.3		10.6	10.4		9.6	9.3		7.5	7.5	240
245									12			11.3		10.6	10.3		9.6	9.3		7.5	7.5	245
250												11.3			10.3			9.3		7.5	7.5	250
255															10.3			9.3			7.5	255
260																		9.3			7.5	260
265																		9.3			7.5	265
270																					7.5	270

* adapter · pièce d'adaptateur

t_240_004_51501_00_000

Lifting capacities Forces de levage

TN

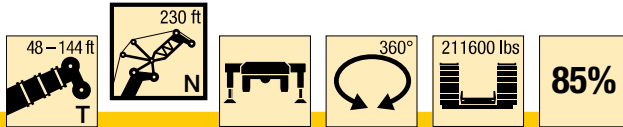

ft	48 + 11.5 ft*			64 + 11.5 ft*			80 + 11.5 ft*			96 + 11.5 ft*			112 + 11.5 ft*			128 + 11.5 ft*			144 + 11.5 ft*			ft
	230 ft			230 ft			230 ft			230 ft			230 ft			230 ft			230 ft			
	82°	75°	68°	82°	75°	68°	82°	75°	68°	82°	75°	68°	82°	75°	68°	82°	75°	68°	82°	75°	68°	
85	15.8																					85
90	15.6			14.9			13.7															90
95	15.5			14.7			13.7			12.2			10.5									95
100	15.3			14.6			13.6			12.1			10.5			8.8				6.5		100
105	15.1			14.5			13.5			12.1			10.4			8.8				6.4		105
110	14.9			14.3			13.4			12			10.4			8.8				6.2		110
115	14.7			14.2			13.3			12			10.4			8.7				6.1		115
120	14.5	14.2		14			13.2			11.9			10.4			8.7				6		120
125	14.2	14.2		13.8	13.5		13.1			11.9			10.3			8.7				5.9		125
130	14	14.1		13.6	13.5		13	12.6		11.8			10.3			8.7				5.9		130
135	13.8	13.9		13.4	13.4		12.8	12.6		11.7	11.3		10.3			8.6				5.9		135
140	13.5	13.7		13.1	13.3		12.6	12.5		11.6	11.2		10.3	9.9		8.6				5.8		140
145	13.3	13.4		12.9	13.1		12.4	12.5		11.5	11.2		10.2	9.9		8.6	8.2			5.8		145
150	13	13.2	13	12.7	12.9		12.2	12.4		11.4	11.2		10.2	9.9		8.6	8.2			5.8	5.3	150
155	12.8	13	13	12.5	12.7	12.3	12	12.2		11.2	11.2		10.2	9.9		8.6	8.3			5.8	5.3	155
160	12.5	12.7	12.9	12.2	12.4	12.3	11.8	12		11.1	11.1		10.1	9.9		8.6	8.3			5.8	5.4	160
165	12.2	12.4	12.7	12	12.2	12.3	11.6	11.8	11.3	10.9	11		10.1	9.9		8.6	8.4			5.8	5.4	165
170	12	12.2	12.4	11.7	12	12.2	11.4	11.6	11.4	10.8	10.9	10.1	9.9	9.8		8.6	8.4			5.8	5.5	170
175	11.7	11.9	12.2	11.5	11.7	12	11.2	11.4	11.4	10.6	10.7	10.2	9.8	9.7		8.6	8.4			5.8	5.5	175
180	11.5	11.7	11.9	11.3	11.5	11.8	11	11.2	11.4	10.4	10.6	10.2	9.6	9.6	8.8	8.6	8.4			5.8	5.6	180
185	11.3	11.5	11.7	11.1	11.3	11.5	10.8	11	11.2	10.3	10.4	10.2	9.5	9.5	8.9	8.5	8.4	7.3		5.8	5.7	185
190	11.1	11.3	11.4	10.9	11.1	11.3	10.6	10.8	11.1	10.1	10.3	10.2	9.4	9.4	9	8.4	8.4	7.4		5.8	5.7	190
195	11	11.1	11.2	10.7	10.9	11.1	10.4	10.6	10.9	9.9	10.1	10.2	9.3	9.3	9	8.4	8.3	7.4	5.8	5.8	5.5	195
200	10.9	10.9	11	10.6	10.7	10.9	10.3	10.4	10.7	9.8	9.9	10.1	9.1	9.2	9.1	8.3	8.3	7.5	5.8	5.9	5.6	200
205	10.7	10.8	10.9	10.5	10.6	10.7	10.2	10.3	10.5	9.7	9.8	9.9	9	9.1	9.1	8.2	8.2	7.6	5.8	6	5.7	205
210	10.5	10.6	10.7	10.4	10.4	10.5	10	10.1	10.3	9.6	9.7	9.8	8.9	9	9.1	8.2	8.2	7.7	5.8	6	5.8	210
215	10.3	10.5	10.6	10.3	10.3	10.4	10	10	10.1	9.5	9.5	9.7	8.9	8.9	9	8.1	8.1	7.8	5.8	6	5.8	215
220	10	10.4	10.4	10.3	10.2	10.2	9.9	9.9	10	9.5	9.4	9.6	8.8	8.8	8.9	8.1	8	7.8	5.8	6	5.9	220
225	9	10.4	10.4	10	10.1	10.1	9.9	9.8	9.9	9.4	9.3	9.4	8.8	8.7	8.8	8	8	7.8	5.8	6	6	225
230	7.7	10.4	10.3	9	10.1	10	9.5	9.7	9.7	9.4	9.3	9.3	8.8	8.7	8.7	7.9	7.9	7.8	5.8	6	6	230
235		9.4	10.3		10.1	10	8.7	9.7	9.7	9.4	9.2	9.2	8.6	8.6	8.6	7.8	7.9	7.8	5.8	6	6	235
240			10.3		9.6	10		9.7	9.6		9.2	9.1	8	8.6	8.6	7.3	7.9	7.8	5.8	6	6	240
245			9.7			10		9.7	9.6		9.2	9.1		8.6	8.5		7.8	7.7		6	6	245
250						10			9.6		9.2	9.1		8.6	8.4		7.8	7.7		6	6	250
255									9.6			9		8.6	8.4		7.8	7.7		6	6	255
260												9			8.4		7.8	7.7		6	6	260
265												9			8.4			7.6		6	6	265
270															8.4			7.6		6	6	270
275																		7.6		6	6	275
280																				6	6	280

* adapter · pièce d'adaptateur

t_240_004_51601_00_000

Lifting heights Hauteurs de levage

TN

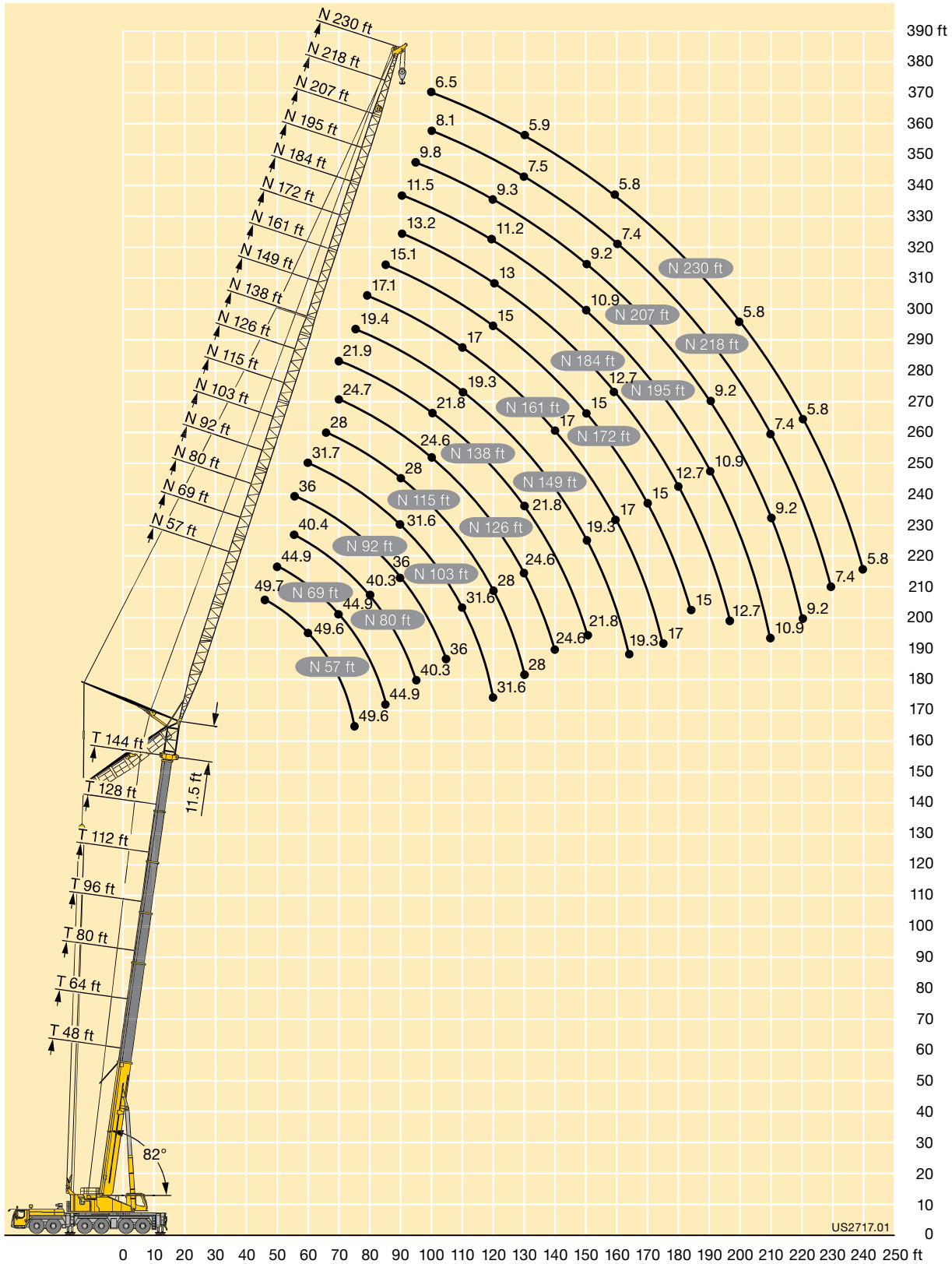

Crane carrier

Frame	Self-manufactured, torsion-resistant box-type design of high-tensile fine grained structural steel.
Outriggers	4-point supporting system, hydraulically telescopic into horizontal and vertical direction. Operation with remote control, automatic support leveling, electronic inclination display.
Engine	8-cylinder Diesel, make Liebherr, watercooled, output 450 kW (612 h.p.), max. torque 2107 lbs-ft. Exhaust emissions acc. to 97/68/EG and EPA/CARB. Fuel reservoir: 211 gallons.
Transmission	Automatic transmission system with torque converter and intarder, make ZF, type TC-TRONIC with 12 forward speeds and 2 reverse speeds, transfer case with transfer differential.
Axles	Low maintenance carrier axles, all 6 axles steered. Axle 1, 3 and 5 are equipped with planetary gears, all driven axles with transverse differential locks, axle 3 with longitudinal differential lock.
Cardan shaft	All cardan shafts with 70° diagonal toothing and maintenance free.
Suspension	All axles are hydro-pneumatically suspended with automatic leveling. Suspension hydraulically lockable.
Tyre equipment	12 tyres, all axles equipped with single tyres. Size of tyres: 445/95 R 25 (16.00 R 25).
Steering	2-circuit system with hydraulic servo steering. Active speed depending rear axle steering, special steering programs for various driving situations.
Brakes	Service brake: all-wheel servo-air brake, all axles are equipped with disc brakes, dual circuit. Additional brakes: exhaust flap brake, Telma Eddy current brake (optional), intarder in gearbox. Hand brake: Spring-loaded, acting on all wheels of axles 2 to 6.
Driver's cab	Spacious corrosion resistant with comfort furnishings, mounted on rubber shock absorbers, safety glazing.
Electrical system	Modern data bus technique, 24 Volt DC, 2 batteries of 170 Ah each.

Crane superstructure

Frame	Liebherr-manufactured, torsionally rigid steel construction made from high-tensile fine-grain steel. Triple-roller slewing rim.
Crane drive	Mechanical drive of the crane hydraulic from the chassis. Variable axial piston pumps with servo control and power regulation.
Crane control	Two self-centering control levers (joy-sticks). Pedal switches for telescoping. Infinitely variable crane motions through displacement control of the hydraulic pumps. Additional working speed control by variation of the Diesel engine speed.
Hoist gear	Axial piston variable displacement motor, hoist drum with integrated planetary gear and spring-loaded static brake. Actuation by closed regulated oil circuit.
Luffing gear	1 differential hydraulic ram with nonreturn valve.
Slewing gear	Axial piston fixed displacement motor, planetary gear, spring-loaded static brake. Actuation by closed regulated oil circuit.
Crane cab	Large screen area, compound glass, comfort furnishing, cabin tilttable 20° to rear.
Safety devices	LICCON2 safe load indicator, test system, hoist limit switches, safety valves against rupture of pipes and hoses.
Counterweight	123500 lbs
Telescopic boom	1 base section and 6 telescopic sections. All telescopic sections extendable individually by means of the rapid-cycle telescoping system TELEMATIK. Boom length 48 ft to 256 ft.

Additional equipment

Swing-away jib K/NZK	41 ft – 115 ft long, mountable to the telescopic boom at 0°, 20° or 40°, integrated erection jib of 18 ft (option). Hydraulic ram for operating the swing-away jib from 0° – 40° (option).
Lattice jibs F/N	Fixed lattice jib 46 ft – 138 ft long, at 0°, 20°, 40° (F), luffing lattice jib 57 ft – 230 ft m long (N).
Additional counterweight	4 additional counterweight slabs of 22050 lbs each for a total counterweight of 211650 lbs.
2nd hoist gear	For 2-hook operation or for operating the luffing lattice jib.
Tyre equipment	12 tyres, size 525/80 R 25 (20.5 R 25).
Drive 12 x 8	The 4th axle is driven additionally.

Other items of equipment available on request.

Châssis porteur

Châssis	Châssis résistant à la torsion de fabrication Liebherr, en acier à grains fins très résistant.
Stabilisateurs	Dispositif de calage horizontal et vertical en 4 points, entièrement déployable hydrauliquement. Utilisation avec commande à distance, mise à niveau automatique du calage, inclinomètre électronique.
Moteur	Moteur diesel, 8 cylindres, fabriqué par Liebherr, à refroidissement par eau, de 450 kW (612 ch), couple max. 2107 lbs-ft. Emissions des gaz d'échappement conformes aux directives 97/68/EG et EPA/CARB. Capacité du réservoir à carburant: 211 gallons.
Boîte de vitesse	Boîte automatique avec convertisseur de couple et ralentisseur, marque ZF, type TC-TRONIC avec 12 marches AV et 2 marches AR, boîte de transfert avec différentiel répartiteur.
Essieux	Essieux nécessitant peu d'entretien, les 6 essieux sont directeurs. Les essieux 1, 3 et 5 sont des essieux planétaires, tous les essieux moteurs avec différentiel transversal et l'essieu 3 avec différentiel longitudinal.
Arbres articulés	Tous les flasques de croisillons avec denture en croix 70° et sans entretien.
Suspension	Tous les essieux sont à suspension hydro-pneumatique avec mise à niveau automatique. Suspension blocable hydrauliquement.
Pneumatiques	12 roues à monte simple. Taille: 445/95 R 25 (16.00 R 25).
Direction	2 circuits avec direction assistée hydraulique. Direction active des essieux arrière et dépendante de la vitesse, programmes de direction spéciaux pour les différents modes de déplacement.
Freins	Freins de service: servofrein à air comprimé, tous les essieux sont munis de freins à disque, à 2 circuits. Freins auxiliaire : par clapet sur échappement, frein Telma (option), ralentisseur monté sur boîte de vitesse. Frein de secours et frein à main: par cylindres à ressorts sur les essieux 2 à 6.
Cabine	Spacieuse cabine, traitement anticorrosion, équipement «grand confort», suspension par silentbloks, vitrage de sécurité.
Installation électrique	Technique moderne de transmission de données par BUS de données, courant continu 24 Volts, 2 batteries de 170 Ah chacune.

Partie tournante

Châssis	Fabrication Liebherr, construction soudée indéformable, en acier à grain fin haute résistance. Couronne d'orientation à triple rangée de rouleaux.
Entraînement	Entraînement mécanique de l'hydraulique de la grue par le châssis de la grue. Pompes réglables à pistons axiaux avec servocommande et réglage de puissance.
Commande	2 leviers à 4 directions avec rappel automatique au point mort. Commande des mouvements progressive en continu par variation de l'inclinaison des pompes et augmentation du régime moteur.
Treuil	Moteur hydraulique à cylindrée variable, treuil avec réducteur planétaire à frein d'arrêt à lamelles intégrées, en circuit hydraulique ferme.
Relevage de flèche	1 vérin hydraulique différentiel avec clapet anti-retour de sécurité.
Orientation	Moteur à cylindrée constante à pistons axiaux, engrenage planétaire, frein d'arrêt commandé par ressort en circuit hydraulique ferme.
Cabine de grue	Large champ de vision, vitrage de sécurité, équipement pour un confort idéal, cabine inclinable de 20° vers l'arrière.
Sécurités	Contrôleur de charge LICCON2, système test, fin de course crochet haut, clapets de sécurité en cas de ruptures de flexibles.
Contrepoids	123500 lbs
Flèche télescopique	Un élément de base et de 6 télescopes. Chaque partie peut être télescopée individuellement à l'aide du système de télescopage séquentiel rapide TELEMATIK. Longueur de flèche: 48 ft – 256 ft.

















Équipement supplémentaire

Flechette pliante K/NZK	Longueur: 41 ft – 115 ft, montable sous un angle de 0°, 20° ou 40°, flechette de montage intégrée de 18 ft de long (en option). Verin hydraulique pour le relevage de la flechette pliante de 0° à 40° (en option).
Flechettes F/N	Flechette treillis fixe 46 ft – 138 ft long, sous 0°, 20°, 40° (F), flechette treillis à volée variable 57 ft – 230 ft long (N).
Contrepoids complémentaire	4 blocs latéraux de suspension de 22050 lbs pour un contrepoids total de 211650 lbs.
Deuxième treuil	Pour le travail avec 2 crochets ou le relevage de la flechette à volée variable.
Pneumatiques	12 pneus. Taille 525/80 R 25 (20.5 R 25).
Entraînement 12 x 8	Le 4ème essieu est également entraîné.





Autres équipements supplémentaires sur demande.

Description of symbols Explication des symboles

General symbols Symboles généraux

	Page Page		Driving speed Vitesse de translation
	Outriggers Calage		Driving speed – Onroad gear Vitesse de translation – Vitesse de route
	Axle Essieu		Transmission Boîte de vitesse
	Radius Portée		Gear Vitesse
	Boom length Longueur de la flèche		Hookblock / Capacity Moufle à crochet / Capacité de charge
	Boom position Position de la flèche		Hoist gear Treuil de levage
	Counterweight Contrepoids		Crane carrier Châssis porteur
	Tyres Pneumatiques		Crane superstructure Partie tournante de la grue
	Slewing gear / Working area Mécanisme d'orientation / Plage de travail		Gradability Aptitude à gravir les pentes
	Standard Norme		

Crane specific symbols Symboles spécifiques à la grue

	Telescopic boom Flèche télescopique		Fixed lattice jib Fléchette treillis fixe
	Mechanical swing away jib Fléchette pliante mécanique		Luffing fly jib Fléchette treillis à volée variable
	Hydraulic swing away jib Fléchette pliante hydraulique		

Remarks referring to load charts

1. The lifting capacities do not exceed 85 % of the tipping load according to ASME B 30.5.
The crane's structural steelwork is in accordance with EN 13000 and ASME B 30.5.
2. For the calculation of the load charts at least a wind speed of 30 ft/s (9 m/s, 20 mph) and regarding the load a sail area of 1 m² per ton load and a wind resistance coefficient of 1.2 on the load have been taken into account. For lifting of loads with large sail areas and/or high wind resistance coefficients the maximum wind speed as stated in the load charts has to be reduced.
3. Lifting capacities are given in kips.
4. The weight of the hook blocks and hooks is part of the load and therefore it must be deducted from the lifting capacities.
5. Working radii are measured from the slewing centre.
6. The lifting capacities given for the telescopic boom apply if the folding jib is removed.
7. Subject to modification of lifting capacities.
8. Lifting capacities above 298600 lbs / 410000 lbs only with additional pulley block/special equipment.
9. The data of this brochure serves only for general information. All information is provided without warranty. Instructions for the correct commissioning of the crane please take from the operation manual and the load chart book.

Remarques relatives aux tableaux des charges

1. La capacité de charge ne doit pas dépasser 85 % de la charge de basculement conformément à ASME B 30.5.
La structure métallique de la grue est conforme à EN 13000 et ASME B 30.5.
2. Une vitesse de vent de 30 ft/s (9 m/s, 20 mph) minimum, une surface de prise au vent de 1 m² par tonne ainsi qu'un coefficient de résistance au vent de la charge 1,2 sont pris en compte pour le calcul des tableaux de charge. Lorsque des charges ayant une surface de prise au vent et/ou un coefficient de résistance au vent plus élevé(e)s sont levées, la vitesse de vent maximale indiquée dans les tableaux de charge doit être réduite.
3. Les charges sont indiquées en kips.
4. Le poids du crochet de levage resp. de la moufle à crochet est une partie de la charge et doit donc être déduit de la capacité de charge.
5. Les portées sont calculées à partir de l'axe de rotation.
6. Les charges indiquées pour la flèche télescopique sont valables lorsque la fléchette pliante est démontée.
7. Charges données sous réserve de modification.
8. Les charges supérieures à 298600 lbs / 410000 lbs seulement avec moufle additionnel/équipement supplémentaire.
9. Les données de cette brochure sont données à titre informatif. Ces renseignements sont sans garantie. Les consignes relatives à la bonne mise en service de la grue sont disponibles dans le manuel d'utilisation et le manuel de tableaux de charge.

Subject to modification / Sous réserve de modifications

Printed in Germany (3)

TD 240.01.US11.2014

Liebherr-Werk Ehingen GmbH

Postfach 1361, 89582 Ehingen, Germany

☎ +49 73 91 5 02-0, Fax +49 73 91 5 02-33 99

www.liebherr.com, E-mail: info.lwe@liebherr.com

www.facebook.com/LiebherrConstruction